

ROPER RHODES[®]

BATH





YOUR CHOICE.
YOUR STYLE.
YOUR COLOUR.

ROPER RHODES®



CONTENTS

GETTING STARTED



- 06 Our story
- 08 Our people
- 10 Designed by us. Tailored by you
- 12 Be inspired
- 14 Choosing your perfect bathroom
- 16 Your choice. Your style. Your colour

Roper Rhodes

FITTED FURNITURE PRODUCTS

FITTED FURNITURE

- 20 Burford
- 38 Aruba
- 58 Vetro

ADDING THE FINISHING TOUCHES

- 66 Handles
- 68 Strata solid surface worktops
- 70 Integrated basins & worktops
- 72 Compact Grade Laminate worktops
- 73 Laminate worktops
- 74 Our Tap Styles

BASINS & WCs

- 76 Our Basins & WCs
- 85 Flushing solutions
- 87 Wall hung WC frames
- 87 Concealed cisterns

MIRRORS & CABINETS

- 88 Mirrors
- 105 Cabinets

PRICING, TECHNICAL & USEFUL INFORMATION

- 114 Pricing & technical drawings
- 162 Customer service & aftercare

All prices are inclusive of VAT at 20%



Our Story

GREAT BRITISH HERITAGE

Appropriately founded in the home of bathing, Roper Rhodes was established in 1979 in the beautiful city of Bath, which we still call our home today. It's been over 40 years since then where we have grown and changed along with the city. Furthermore our passion for design, ingenuity and creativity has never been stronger.

Our products are made with consideration as well as stringently tested to ensure uncompromising performance and durability. Such is the confidence in our designs that our ranges are covered by extensive guarantees for your peace of mind. For example you can relax knowing you will receive a 20 year guarantee against defects in manufacture on sanitaryware and 10 years on our furniture.

We have a rich history but are also obsessed with product development; constantly innovating, with each new product launch seen as an opportunity to improve the lives of our customers. We work on the basis that every aspect of the life of our products must be considered, challenged and designed to be better. This approach has resulted in us having a market leading product innovation vitality score.



Our People

GREAT BRITISH DESIGN

For over forty years, we at Roper Rhodes have striven for bathroom perfection. Our dedicated team has grown from just one man to a group of people obsessed with all the little details that go into making your dream bathroom.

At every step of the way the customer is at the forefront of our minds. Starting with our product designers, who are always in search of how they can improve the bathroom experience. Push-button showers and contactless flushing are just some of the innovations to come from our team of designers.

Once a product has been made, it finds itself within our impressive 200,000 Sq ft Distribution Centre on the outskirts of Bristol. Here we run a twenty-four-hour operation to guarantee you the best delivery and service we can.

We believe that beautiful bathrooms come from our people, who's inspiration and dedication have made Roper Rhodes what it is today.



Roper Rhodes

DESIGNED BY US. TAILORED BY YOU.

Fitted furniture is all about taking the space you have and making it reach its full potential. Unrestricted and completely customisable, fitted furniture gives you the flexibility & storage you need, with the style you love.

Whether you live in a Victorian townhouse, an ultra-modern apartment, or something a little more unusual, our boundless combinations of fitted furniture styling options give you the ability to create a bathroom that feels uniquely and effortlessly 'you'.

What will you be...



Be Timeless

CAPTURE THE CLASSICS

Discover the timeless look and feel of traditional carpentry, with all the advantages of fitted furniture in our Burford range. Keep things classic or add a more contemporary twist with this versatile collection of shaker-style furniture.



Be Modern

SEIZE THE STYLE

Made for the modern home, Aruba's sleek, slab doors and sophisticated styling sets it apart. Aruba offers effortless style in a wide range of on-trend finishes.



Be Unique

MAKE YOUR MARK

Create something truly distinctive with the glass-like finishes of Vetro. This ultra-contemporary range of high-gloss fitted furniture enables you to create a truly luxurious, bespoke look.

THE CHOICE IS YOURS...

Be inspired ...

HOW TO GET THE FITTED LOOK *with Zoe Jones*



BE INSPIRED

Our in-house stylist Zoe gives you her tips on how to style fitted furniture.

Fitted furniture is all about mixing and matching to create a unified look. First, choose the perfect base like our Burford furniture in Juniper Green, and then accessorise to inject your own style. We've chosen timeless elements such as our Thesis oval mirror and the smooth curves of our Cover sanitaryware, and paired these with contemporary brass accessories and leafy foliage to keep it feeling fresh.



@roperrhodes



'Why not try bringing together contrasting textures with rustic woods, brass accessories, or ceramic tiles in modern designs?'

BE A PART OF IT

Be a part of our community by tagging us in a photo of your finished project with **#roperrhodes**, and you might just feature in our next brochure!



@_itslucy__



TAILOR YOUR LOOK

Don't forget the finishing touches. Customise your look with our extensive range of mirrors, cabinets, taps and sanitaryware.



Cover basin page 80



Elate brass tap page 74



Thesis oval mirror page 101



Fresno brass handle page 66



Cover wall hung WC page 80

Plan your bathroom ...

CHOOSING YOUR PERFECT BATHROOM

Roper Rhodes fitted furniture is full of choice and bespoke features. Follow our guide below for a quick overview and understanding of how to create your very own Roper Rhodes fitted furniture bathroom. A more detailed planning guide can be found on pages 64-75.



01

BE INSPIRED

Before beginning your journey, why not check out Instagram, Pinterest or the pages of this brochure to be inspired by our stunning roomset designs and layouts.



02

PLAN YOUR SPACE

Explore your existing bathroom space. Consider any wasted areas which could be maximised with the addition of storage units. We recommend installing your WC unit in a similar position to the current WC to minimise installation costs. Our free swatch sample service makes it easy to choose the right finish for your home. Simply fill out the form on our website to order your own at roperrhodes.co.uk/swatches/

03

SELECT A LOOK

We have three stunning furniture styles to choose from; from the timeless looking Burford, pared-back modern style of Aruba, or the glass-like contemporary edge of Vetro. See pages 18-63 for further details.



TIMELESS

BURFORD



MODERN

ARUBA



UNIQUE

VETRO



04

CHOOSE YOUR ACCESSORIES

Choose from our wide range of handles, worktops and taps to give your bathroom units a bespoke look and feel. See pages 64-75 for all handle & worktop options.

ADD
A CHARGING
STATION TO YOUR
FURNITURE RUN.
SEE P115.

05

COMPLETE YOUR BATHROOM

Complete the design of your new bathroom by choosing from our collection of stylish basins & WCs as well as coordinating taps and elegant mirrors and cabinets. See pages 74-113 for options.



06

SPECIALIST ADVICE

Speak to your local Roper Rhodes bathroom specialist for further advice on layouts and design, as well as assistance in ordering and installation. Find your nearest retailer on our website now. roperrhodes.co.uk/stockists/



07

HERE FOR YOU

Even after you've completed your Roper Rhodes Bathroom, we'll still be here to assist with anything you need.

Product after care, guarantees and access to our customer service team are all available to you, as well as technical support across our website.

For further assistance in planning your bathroom please visit our website to see our Bathroom Buying Guide roperrhodes.co.uk/bathroom-buying-guides/

Plan your bathroom ...

YOUR CHOICE. YOUR STYLE. YOUR COLOUR

Our fitted furniture gives you the flexibility to individualise your bathroom design by ensuring your bathroom space is uniquely 'you'. Whether you live in a Victorian townhouse or an ultra modern home we can reflect your style, creating the look you want.

CONSIDER YOUR CONFIGURATION

Before starting your bathroom renovation, get a feel for your bathroom layout.

It is advisable to install a WC unit in a similar position to the current WC to minimise installation costs. However, if you do want to change the layout a good bathroom retailer will be able to guide you through the planning process.

Roper Rhodes fitted furniture is designed to be used in many different configurations - some typically popular layouts are highlighted below.

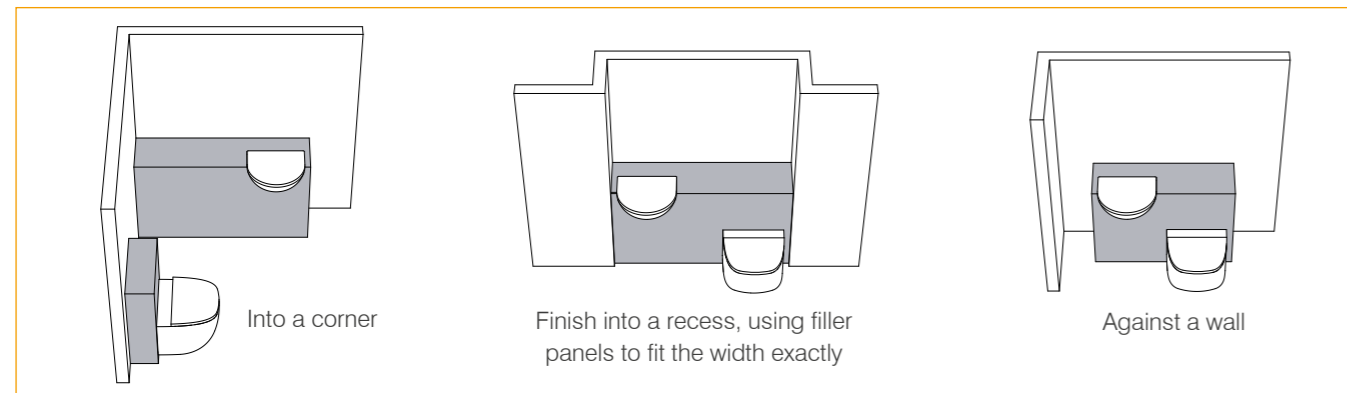

UNIT OVERVIEW

Choose from a range of floor units, wall cupboards and full height 2 door units.



SELECT YOUR UNIT DEPTH

Consider the available space in your bathroom and choose from either standard depth (353mm) or space-saving slim depth (218mm) units.



* Standard depth 353mm (* excludes worktop & basin)
* Slim depth 218mm

PLINTHS & END PANELS



All of our fitted furniture ranges can be wall hung or floor mounted, depending on your desired look. If you opt for floorstanding units, you will need to order colour matched plinths in order to hide the leg supports.

For all fitted furniture you will need to order end panels to complete your look, unless your furniture runs wall to wall. If using end panels in between units to create a framed look, please be aware that one end panel can be cut in half to save costs.



UNIT COLOURS & RECOMMENDED CARCASS COLOUR

The recommended carcass colour can be used with each door finish for best effect, but you can also choose to order whichever carcass colour you wish to achieve your desired look.

Use the chart below to see the suggested carcass and door colour.

FURNITURE RANGE	Jumper Green	Coniston Blue	Derwent Blue	Mercury	Slate Grey	Pebble Grey	Chalk White	Mocha	Powder Grey	Mussel	Gloss Dark Clay	Alpine Elm	Flintwood	White	Vetro Light Grey	Vetro White
BURFORD	●	●	●	●	●	●	●	●								
ARUBA	●		●					●	●	●	●	●	●	○		
VETRO															●	●

RECOMMENDED CARCASS COLOURS

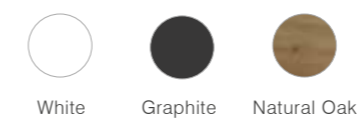



Meet the fitted furniture
DESIGNERS

Our fitted furniture designers understand the ins and outs of what makes a great bathroom. Their creations have been tailor made to give you all you'll need to create your ideal space.

We offer something for every taste, with designs that incorporate a host of thoughtful features such as worktops with integrated basins, colour matched handles and underslung basin units.

FITTED FURNITURE



Timeless styling with a twist

BURFORD

Elements of traditional carpentry with the advantages of fitted furniture in a range of 8 painted finishes.

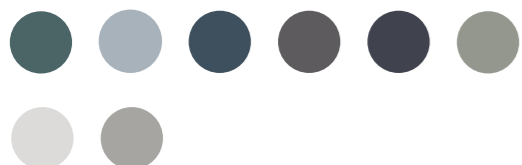



Timeless furniture
BURFORD JUNIPER GREEN

Discover tranquillity with the effortless look and feel of juniper green. Inspired by lush, alpine forests, this finish aims to bring a touch of nature into your space.

Shown in our space saving 218mm slim depth, juniper green is a truly versatile finish. Combine with luxurious brass handles and taps add a touch of drama. Or opt for black finishing touches for a more industrial style.

Discover more of how we created this look on page 12.



FURNITURE
 UNITS HAVE A
 PAINTED
 FINISH

CREATE THIS LOOK

Want to recreate this look for your new bathroom?

This page shows a helpful floor plan and useful list of items used to design this timeless bathroom.

We offer a free colour swatch service. See page 162 for details.

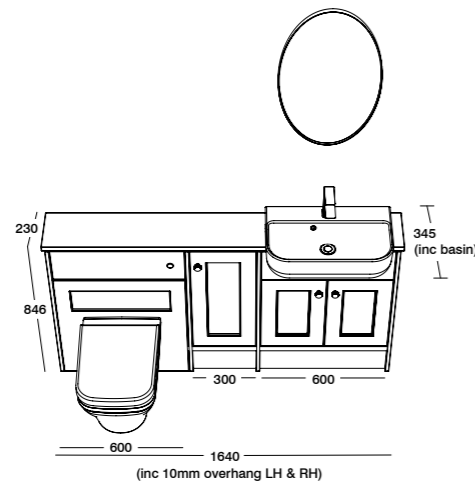

- DOOR: Juniper green
- INTERIOR CARCASS: Graphite
- PANELS & PLINTHS: Juniper green
- WORKTOP: Carrara strata
- SANITARYWARE: Cover
- TAPS: Elate
- HANDLES: Fresno brass
- MIRROR: Thesis oval

- WALL TILES: mandarinstone.com
- FLOOR TILES: capietra.com

TAILOR YOUR LOOK

Blend the deep green hues of Juniper with our smooth Cover basins & WCs and brass accessories.



PAGE 80 Cover basin



PAGE 80 Cover wall hung WC



PAGE 74 Elate tap



PAGE 101 Thesis oval mirror

Timeless furniture
BURFORD CONISTON BLUE

Define your style with this muted tone of Burford coniston blue to create a visual statement, balancing modern and traditional styling.

Complete this classic style with a double basin. Ideal for those wishing to make a real design statement and very practical as well. Opt for the Harrow sanitaryware, Keswick taps and Westport door handles to complete this look and create a beautiful balance between classic styling & dramatic good looks.

Alternatively coniston blue works equally as well with the more contemporary Paradigm basins and WCs for a more timeless look.

For a seamless design include an oval furniture flush button from page 85.



TAILOR YOUR LOOK

Create a distinctive look with the traditional styling of the Harrow sanitaryware range, Keswick tap and Columbus chrome handles.



PAGE 84 Harrow basin



PAGE 84 Harrow back to wall WC



PAGE 75 Keswick tap



PAGE 98 Eminence oval mirror

CREATE THIS LOOK

Want to recreate this look for your new bathroom?

This page shows a helpful floor plan and useful list of items used to design this timeless bathroom.

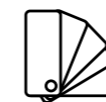
 We offer a free colour swatch service. See page 162 for details.

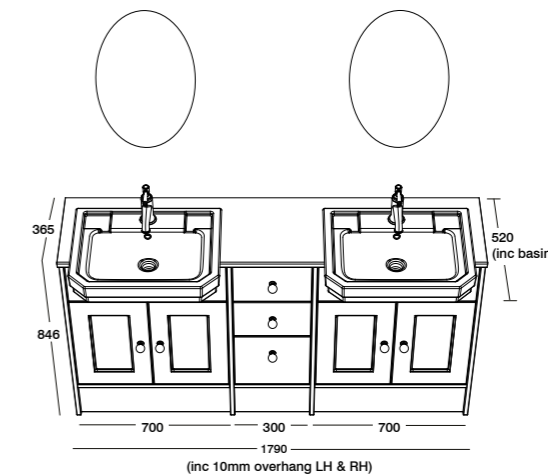

- DOOR: Coniston blue
- INTERIOR CARCASS: Graphite
- PANELS & PLINTHS: Coniston blue
- WORKTOP: Arctic white strata
- SANITARYWARE: Harrow
- TAPS: Keswick
- HANDLES: Westport
- MIRROR: Eminence oval

- WALL LIGHTS: capietra.com
- FLOOR TILES: capietra.com



FURNITURE UNITS HAVE A PAINTED FINISH

Timeless furniture
BURFORD DERWENT BLUE

Strike the perfect balance between modern and traditional with stunning derwent blue; full of character and depth, it combines tailored lines with a touch of classic styling.

This fitted furniture look is brought together by stunning chrome finishing touches. A combination of our Henderson and Columbus handles help create interest and dimension. Whilst the Wessex basin mixer taps the perfect line between modern and traditional to give a contemporary edge.



The Burford range can be used with contemporary sanitaryware to create a different look

CREATE THIS LOOK

Want to recreate this look for your new bathroom?

This page shows a helpful floor plan and useful list of items used to design this timeless bathroom.

We offer a free colour swatch service. See page 162 for details.

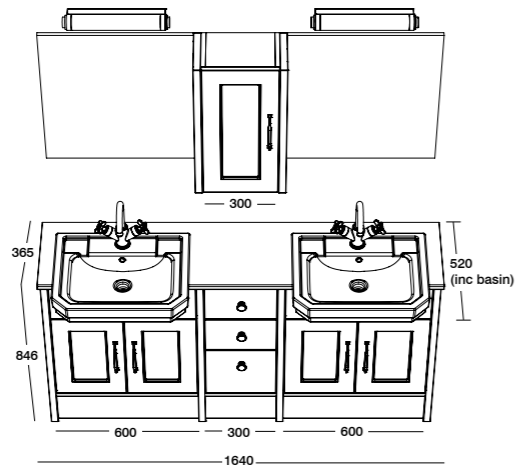

- DOOR: Derwent blue
- INTERIOR CARCASS: Graphite
- PANELS & PLINTHS: Derwent blue
- WORKTOP: Carrara strata
- SANITARYWARE: Harrow
- TAPS: Wessex
- HANDLES: Henderson & columbus
- LIGHTS: Traditional wall light
- WALLPAPER: houseofhackney.com
- FLOOR TILES: tiles-direct.com

TAILOR YOUR LOOK

Make a design statement with our Harrow basins paired with our timeless Accent back to wall WCs.



PAGE 84 Harrow basin



PAGE 84 Harrow back to wall WC



PAGE 75 Wessex tap



PAGE 98 550mm Eminence circular mirror

Timeless furniture

BURFORD MERCURY

This understated and elegant shade is perfect for creating a modern-classic look.

Burford's simple styling has framed doors, plinths with rails and tongue and groove feature panels. The strong lines this creates are particularly complemented by Harrow sanitaryware.



FURNITURE UNITS HAVE A PAINTED FINISH

TAILOR YOUR LOOK

Add a touch of minimalism to your bathroom by opting for the clean lines of the City basin with its integrated worktop.



PAGE 84 Harrow basin



PAGE 84 Harrow back to wall WC



PAGE 70 City basin with integrated worktop



PAGE 104 Traditional mirror

CREATE THIS LOOK

Want to recreate this look for your new bathroom?

This page shows a helpful floor plan and useful list of items used to design this timeless bathroom.

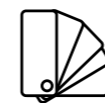

We offer a free colour swatch service. See page 162 for details.

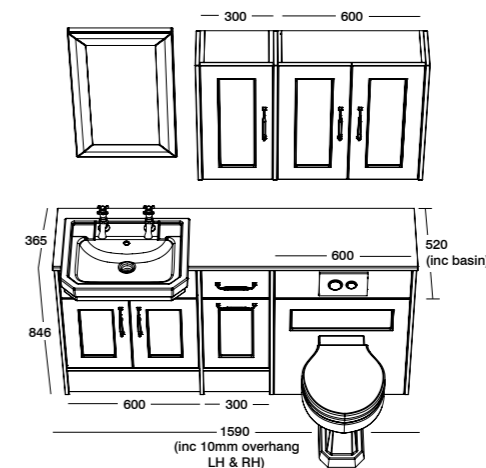

- DOOR: Mercury
- INTERIOR CARCASS: Graphite
- PANELS & PLINTHS: Mercury
- WORKTOP: Carrara strata
- SANITARYWARE: Harrow
- TAPS: Henley
- HANDLES: Columbus
- MIRROR: Traditional mirror

FLOOR TILES: mandarinstone.com



Timeless furniture
BURFORD SLATE GREY

Create real drama with this deep slate grey finish. A nod to heritage styling, this finish will give your bathroom a sophisticated yet modern feel.

Opt for a Geo basin and Strata worktop or keep everything sleek and seamless by choosing the City underslung basin with integrated solid surface worktop. Using two full height twin door cupboards together will give you masses of valuable storage space.



FURNITURE
 UNITS HAVE A
 PAINTED
 FINISH



CREATE THIS LOOK

Want to recreate this look for your new bathroom?

This page shows a helpful floor plan and useful list of items used to design this timeless bathroom.

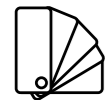

We offer a free colour swatch service. See page 162 for details.

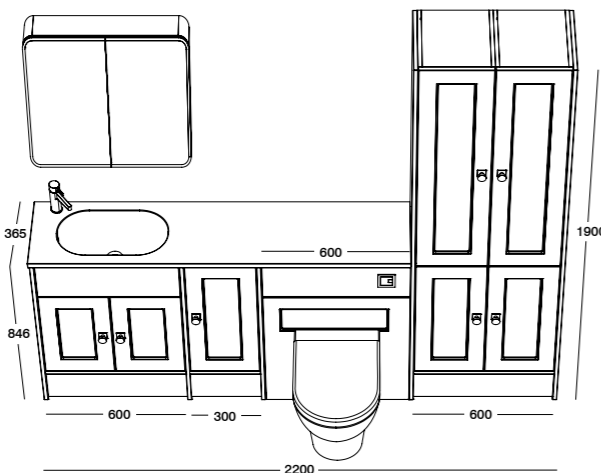

- DOOR: Slate grey
- INTERIOR CARCASS: Natural oak
- PANELS & PLINTHS: Slate grey
- WORKTOP & BASIN: City Basin
- SANITARYWARE: Note
- HANDLES: Berkeley
- MIRRORED CABINET: System
- FLOOR TILES: toppstiles.co.uk

TAILOR YOUR LOOK

Add some additional storage to your bathroom with our full height twin door cupboards and Note sanitaryware, or City basin for a stylish on trend look.



PAGE 83 Geo basin



PAGE 81 Note back to wall WC



PAGE 70 City basin with integrated worktop



PAGE 111 600mm System illuminated cabinet

Timeless furniture
BURFORD PEBBLE GREY

For a new take on a classic look opt for the muted tones of pebble grey finish, creating a relaxed & calming environment.

Open shelving and sleek mirrors, used together here with the smooth arctic white Strata solid surface worktop and Geo basin help create this timeless look.

Use 30mm end panels between the units to create a more traditional framed look. For economy these end panels can be cut in half for use within a run if desired.

TOP TIP



FURNITURE UNITS HAVE A PAINTED FINISH

TAILOR YOUR LOOK

Open shelving used with the smooth arctic white Strata solid surface worktop and Geo basin help create a timeless look.



PAGE 83
Geo sanitaryware



PAGE 66
Washington handle



PAGE 66
Caldwell handle



PAGE 75
Wessex tap

CREATE THIS LOOK

Want to recreate this look for your new bathroom?

This page shows a helpful floor plan and useful list of items used to design this timeless bathroom.



We offer a free colour swatch service. See page 162 for details.

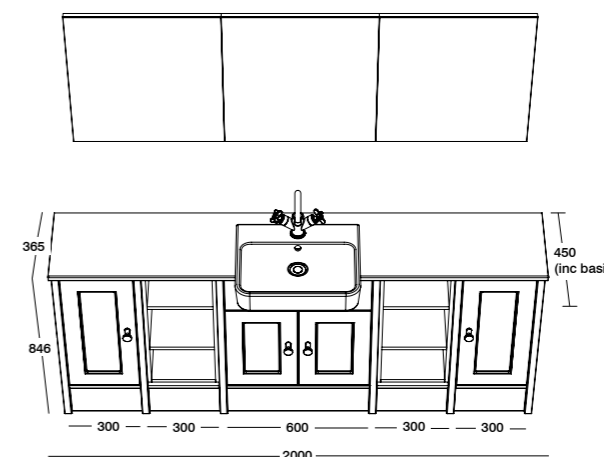

- DOOR: Pebble Grey
- INTERIOR CARCASS: Natural oak
- PANELS & PLINTHS: Pebble grey
- WORKTOP: Arctic white strata
- SANITARYWARE: Geo
- TAPS: Wessex
- HANDLES: Caldwell

- WALL TILES: porcelanosa.com
- FLOOR TILES: mandarinstone.com



FURNITURE
UNITS HAVE A
PAINTED
FINISH

Timeless furniture
BURFORD CHALK WHITE

In a soft white, Burford has a classic look with framed doors.

Recommended for use with natural oak finish carcass units, a coordinating oak finish worktop is also available.

Use 30mm end panels between the units to create a more traditional framed look and finish with Washington chrome handles.



CREATE THIS LOOK

Want to recreate this look for your new bathroom?

This page shows a helpful floor plan and useful list of items used to design this timeless bathroom.

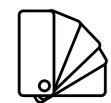
 We offer a free colour swatch service. See page 162 for details.

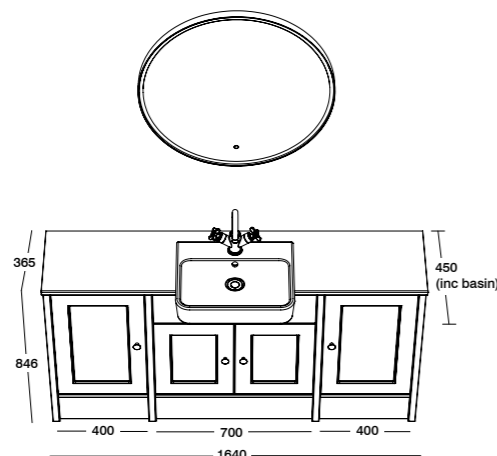

- DOOR: Chalk white
- INTERIOR CARCASS: Natural oak
- PANELS & PLINTHS: Chalk white
- WORKTOP: Natural oak laminate
- SANITARYWARE: Geo
- TAP: Wessex
- HANDLES: Washington chrome
- MIRROR: 800mm frame circular

FLOOR TILES: parador.de/en/

TAILOR YOUR LOOK

Create a distinctive look to your bathroom with the soft tones of Burford chalk white paired with the traditional styling of our Wessex tap.



PAGE 83 Geo sanitaryware



PAGE 66 Washington handle



PAGE 75 Wessex tap



PAGE 97 800mm Frame circular mirror

Timeless furniture
BURFORD MOCHA

The muted tone of Burford mocha adds to its timeless appeal and really suits the classic styling.

Recommended for use with natural oak finish carcass units, a coordinating oak finish worktop is also available.

Use 30mm end panels between the units to create a more traditional framed look and finish with Washington chrome handles.



TAILOR YOUR LOOK

The muted tones of mocha work well with our Geo sanitaryware, Henley taps and simple mirrors.



PAGE 83 Geo basin



PAGE 83 Geo back to wall WC



PAGE 75 Henley basin mixer



PAGE 66 Washington handle

CREATE THIS LOOK

Want to recreate this look for your new bathroom?

This page shows a helpful floor plan and useful list of items used to design this timeless bathroom.

 We offer a free colour swatch service. See page 162 for details.

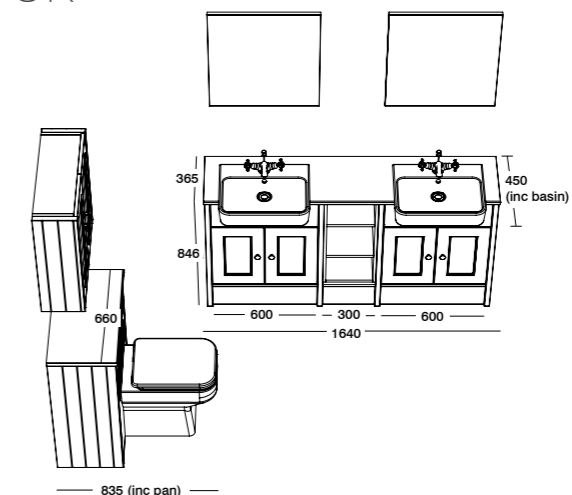

- DOOR: Mocha
- INTERIOR CARCASS: Natural oak
- PANELS & PLINTHS: Mocha
- WORKTOP: Arctic white strata
- SANITARYWARE: Geo
- TAPS: Henley
- HANDLES: Washington chrome
- WALL TILES: mandarinstone.com

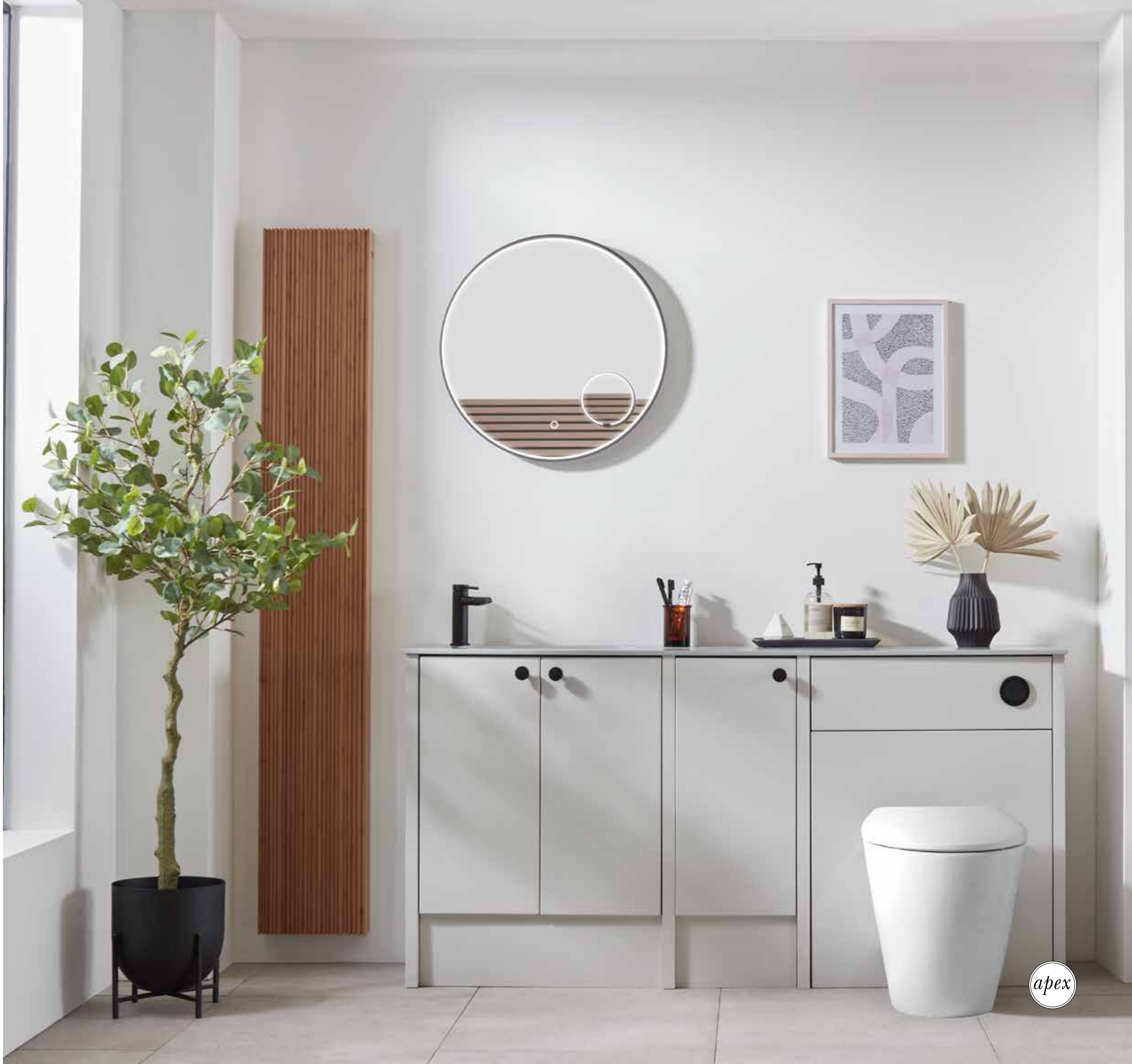

Modern Sophisticated Style

ARUBA

A simple, ultra modern style for effortless cool in 9 on-trend finishes.



apex



600MM
UNDERSLUNG
BASIN & UNIT

FURNITURE
UNITS HAVE A
PAINTED
FINISH

Modern Furniture
ARUBA JUNIPER GREEN

Inspired by nature, the sleek and modern finish of Aruba juniper green brings a sense of calm and tranquillity.

We've combined this finish with our new compact grade laminate worktop in grey slate, for a stylish yet practical look. These worktops are specifically designed to be hardwearing and waterproof. They also work perfectly with our new underslung basin & unit, see more on page 72.



COLOUR
MATCHED
HANDLES



COMPACT
GRADE
LAMINATE
WORKTOPS



CREATE THIS LOOK

Want to recreate this look for your new bathroom?

This page shows a helpful floor plan and useful list of items used to design this timeless bathroom.

We offer a free colour swatch service. See page 162 for details.

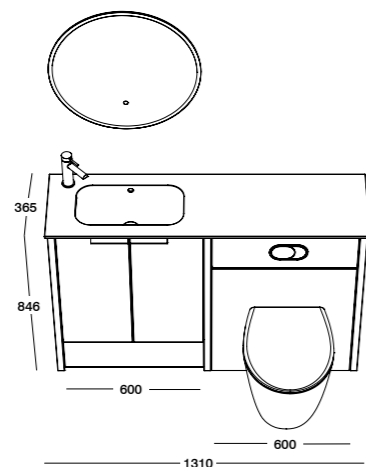

- DOOR: Juniper green
- INTERIOR CARCASS: Graphite
- PANELS & PLINTHS: Juniper green
- WORKTOP: CGL slate grey laminate
- SANITARYWARE: Paradigm
- TAPS: Storm-Nova
- HANDLES: Catalina
- MIRROR: Thesis circular mirror

- WALL TILES: capietra.com
- FLOOR TILES: claybrookstudio.co.uk
- WALL CLADDING: oracdecor.com

TAILOR YOUR LOOK

For a seamless look, why not opt for our new underslung basin unit? Or for a more traditional look, choose our Paradigm semi-countertop basin.



PAGE 72 Underslung basin unit



PAGE 78 Paradigm basin



PAGE 74 Storm-Nova



PAGE 101 600mm Thesis circular mirror

Modern Furniture

ARUBA POWDER GREY

Discover our true neutral powder grey finish. Perfect for achieving a soft, minimalistic feel in the bathroom.

We've opted for black handles, taps and accessories to add a contemporary twist to this effortless finish. Paired with our new underslung basin unit with super durable compact grade laminate worktop. Plus, add a practical element to your unit with our internal charging station, perfect for toothbrushes or shavers. See more on page 112.



COMPACT GRADE LAMINATE WORKTOPS



ADD A CHARGING STATION TO YOUR FURNITURE RUN



600MM UNDERSLUNG BASIN & UNIT

FURNITURE UNITS HAVE A PAINTED FINISH

TAILOR YOUR LOOK

Add a touch of minimalism to your bathroom by opting for the clean lines of the underslung basin and compact grade worktop.



PAGE 72 Underslung basin unit



PAGE 112 Charging station



PAGE 74 Storm-Nova



PAGE 94 Loop wall & vanity mirror

CREATE THIS LOOK

Want to recreate this look for your new bathroom?

This page shows a helpful floor plan and useful list of items used to design this timeless bathroom.

We offer a free colour swatch service. See page 162 for details.

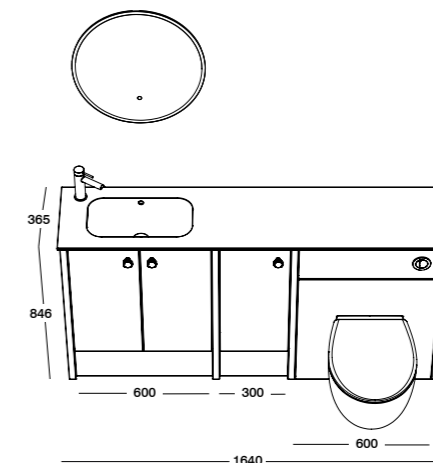

- DOOR: Powder grey
- INTERIOR CARCASS: Graphite
- PANELS & PLINTHS: Powder grey
- WORKTOP: CGL Concrete laminate
- SANITARYWARE: Paradigm
- TAPS: Storm-Nova
- HANDLES: Fresno
- MIRROR: Loop

WALL TILES: capietra.com



FURNITURE UNITS HAVE A PAINTED FINISH

Modern Furniture
ARUBA MUSSEL

Soft and inviting, this muted finish makes the perfect neutral backdrop to suit any style or design.

Our simple, Paradigm sanitaryware is the ideal match for this muted finish. Pair yours with black handles and worktop to add a contemporary edge. Why not add our internal charging station, perfect for toothbrushes or shavers. See more on page 112.



ADD A CHARGING STATION TO YOUR FURNITURE RUN

CREATE THIS LOOK

Want to recreate this look for your new bathroom?

This page shows a helpful floor plan and useful list of items used to design this timeless bathroom.

We offer a free colour swatch service. See page 162 for details.

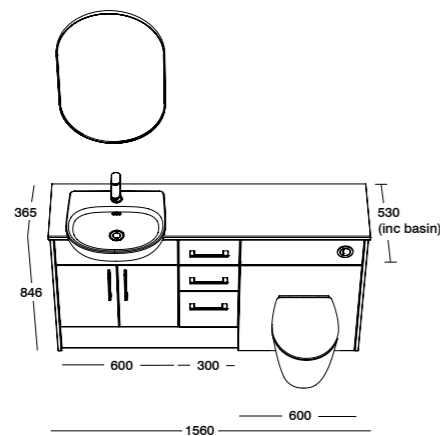

- DOOR: Mussel
- INTERIOR CARCASS: Graphite
- PANELS & PLINTHS: Mussel
- WORKTOP: Starlight strata
- SANITARYWARE: Paradigm
- TAPS: Clear
- HANDLES: Madison
- MIRROR: Thesis pill

WALL TILES: mandarinstone.com
FLOOR TILES: mandarinstone.com

TAILOR YOUR LOOK

Super charge your bathroom with our optional charging station.



PAGE 78 Paradigm sanitaryware



PAGE 112 Charging station



PAGE 74 Clear tap



PAGE 101 Thesis pill mirror

Modern Furniture

ARUBA DERWENT BLUE

Dive in at the dark deep end and inject a splash of colour into your bathroom with this sleek flat door style in rich derwent blue. Full of warmth and character it's sure to make the right statement. This fabulous hue offers a sophisticated look that is sure to enrich your bathroom design.

Why not elevate your bathroom space and opt for the Motif solid surface basin with integrated worktop. We've selected the Stockton brass handle and brass Elate tap for a real design statement to keep your bathroom right on trend.

WHITE, BLACK & BRUSHED BRASS OVERFLOW TRIMS ARE AVAILABLE SEE PAGE 135



FURNITURE UNITS HAVE A PAINTED FINISH



TAILOR YOUR LOOK

Add a touch of minimalism to your bathroom by opting for the clean lines of the Motif basin and integrated worktop.



PAGE 71 Motif basin with integrated worktop



PAGE 81 Note back to wall WC



PAGE 74 Elate tap



PAGE 97 600mm Frame circular mirror

CREATE THIS LOOK

Want to recreate this look for your new bathroom?

This page shows a helpful floor plan and useful list of items used to design this timeless bathroom.

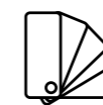

We offer a free colour swatch service. See page 162 for details.

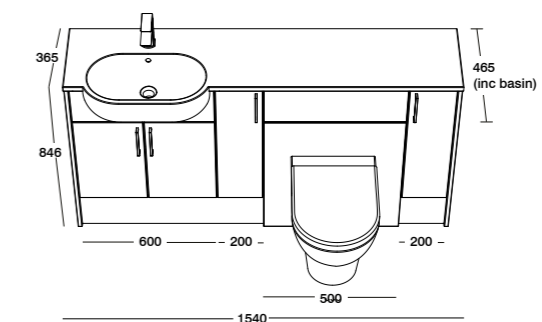

- DOOR: Derwent blue
- INTERIOR CARCASS: Graphite
- PANELS & PLINTHS: Derwent blue
- WORKTOP: Motif basin & worktop
- SANITARYWARE: Note
- TAP: Elate
- HANDLES: Stockton
- MIRROR: 600mm frame

FLOOR TILES: mandarinstone.com



FURNITURE
UNITS HAVE A
PAINTED
FINISH

Modern Furniture
ARUBA GLOSS DARK CLAY

Step things up & bring in an element of luxe to enrich your bathroom design with this glossy dark clay finish. Perfect for creating depth & making a statement.

Keep everything sleek and seamless by choosing the City underslung basin with integrated solid surface worktop. The very practical 3 drawer unit is perfect for all your smaller bathroom items and will keep clutter at bay.



CREATE THIS LOOK

Want to recreate this look for your new bathroom?

This page shows a helpful floor plan and useful list of items used to design this timeless bathroom.

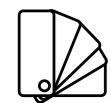
 We offer a free colour swatch service. See page 162 for details.

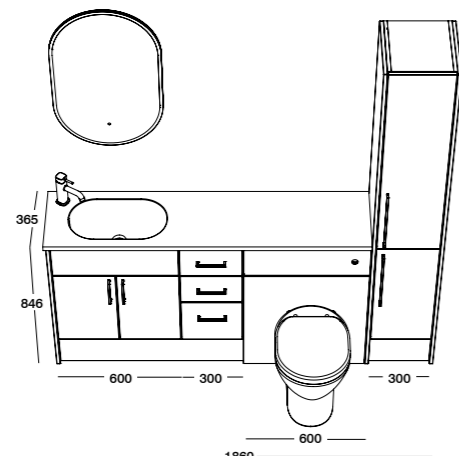

- DOOR: Gloss dark dlay
- INTERIOR CARCASS: Graphite grey
- PANELS & PLINTHS: Gloss dark clay
- WORKTOP: City basin
- SANITARYWARE: Zest
- HANDLES: Stockton
- MIRROR: Eminence pill

FLOOR TILES: mandarinstone.com

TAILOR YOUR LOOK

Bring a sense of style into your bathroom with the aspirational look and feel of the City basin and integrated worktop.



PAGE 70 City integrated basin & worktop



PAGE 82 Zest back to wall WC



PAGE 67 Stockton handle



PAGE 98 Eminence pill mirror

Modern Furniture

ARUBA ALPINE ELM

Cool & light, this contemporary textured finish uses elements from Scandinavian design to create this on-trend stylish look.

The contemporary styling of Aruba works beautifully when contrasted with our matt dark grey, soft touch premium laminate worktop and matt black handles.

Coordinating bath panels are available to complete the room.



TAILOR YOUR LOOK

Add a touch of minimalism to your bathroom by opting for the clean lines of our Geo sanitaryware paired with the smooth curves of our Frame mirrors.



PAGE 83 Geo basin



PAGE 83 Geo back to wall WC



PAGE 67 Stockton handle



PAGE 97 600mm Frame mirror

CREATE THIS LOOK

Want to recreate this look for your new bathroom?

This page shows a helpful floor plan and useful list of items used to design this timeless bathroom.

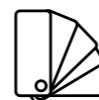

We offer a free colour swatch service. See page 162 for details.

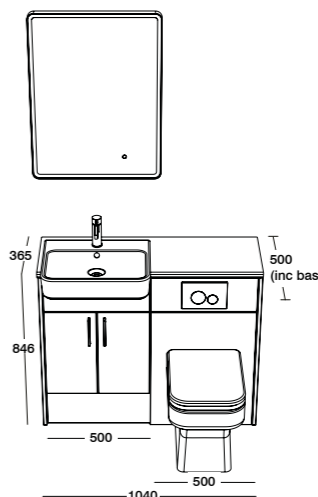

- DOOR: Alpine elm
- INTERIOR CARCASS: Graphite
- PANELS & PLINTHS: Alpine elm
- SANITARYWARE: Geo
- TAP: Storm-Nova
- HANDLES: Stockton
- MIRROR: 600mm frame

FLOOR TILES: tilemountain.co.uk



FURNITURE
UNITS HAVE A
PAINTED
FINISH

Modern Furniture
ARUBA MOCHA

This warm muted tone is perfect for a modern bathroom, especially with its semi-matt finish.

The contemporary styling of Aruba works beautifully when teamed with the sleek massa marble laminate worktop and matt black handles. Our Note or Cover sanitaryware ranges are the perfect choice for this modern aesthetic.



CREATE THIS LOOK

Want to recreate this look for your new bathroom?

This page shows a helpful floor plan and useful list of items used to design this timeless bathroom.

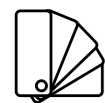

We offer a free colour swatch service. See page 162 for details.

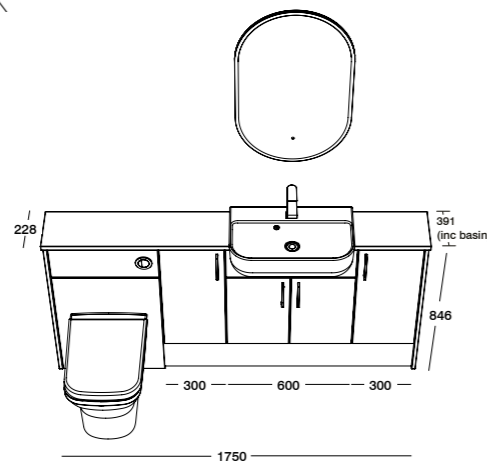

DOOR: Mocha
INTERIOR CARCASS: Natural oak
PANELS & PLINTHS: Mocha
WORKTOP: Massa marble laminate
SANITARYWARE: Cover
HANDLES: Stockton
MIRROR: Eminence pill

WALL TILES: mandarinstone.com
FLOOR TILES: mandarinstone.com

TAILOR YOUR LOOK

Strike the perfect balance between the soft tones of our mocha units and the sleek contemporary feel of our cover sanitaryware.



PAGE 80 Cover basin



PAGE 80 Cover back to wall WC



PAGE 67 Stockton handle



PAGE 98 Eminence pill mirror



Modern Furniture

ARUBA FLINTWOOD

This cool grey wood grain has a natural texture & packs a punch, offering a dramatic look for the bathroom.

Keep the style contemporary with matt black handles, Strata solid surface carrara marble worktop and Cover sanitaryware including the delightful thin edge semi recessed basin.



TAILOR YOUR LOOK

The smooth thin curved design of our Cover sanitaryware adds a sleek pared-back contemporary look to any bathroom.



PAGE 80 Cover basin



PAGE 80 Cover back to wall WC



PAGE 74 Sync tap



PAGE 102 600mm Scheme mirror

CREATE THIS LOOK

Want to recreate this look for your new bathroom?

This page shows a helpful floor plan and useful list of items used to design this timeless bathroom.

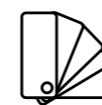

We offer a free colour swatch service. See page 162 for details.

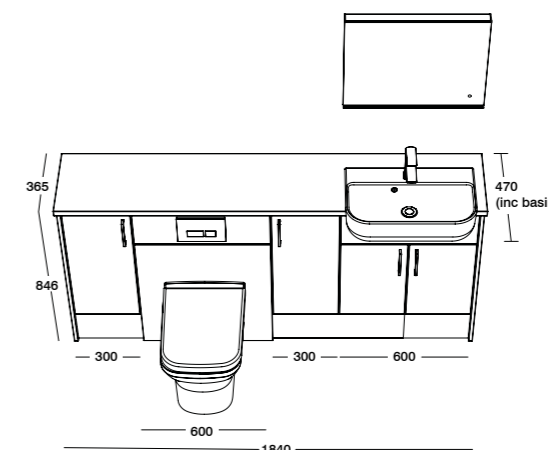

- DOOR: Flintwood
- INTERIOR CARCASS: Silver
- PANELS & PLINTHS: Flintwood
- WORKTOP: Carrara strata
- SANITARYWARE: Cover
- TAPS: Sync
- HANDLES: Stockton black
- MIRROR: 600mm Scheme mirror

FLOOR TILES: mandarinstone.com



Modern Furniture
 ○ ARUBA WHITE

A crisp gloss painted white finish for ultimate simplicity of style.

For this clean, minimal look, combine the Aruba white range with Strata solid surface worktop, and the contemporary thin edged Cover basins. The Washington chrome handle provides the perfect finishing touch.



CREATE THIS LOOK

Want to recreate this look for your new bathroom?

This page shows a helpful floor plan and useful list of items used to design this timeless bathroom.

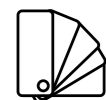

We offer a free colour swatch service. See page 162 for details.

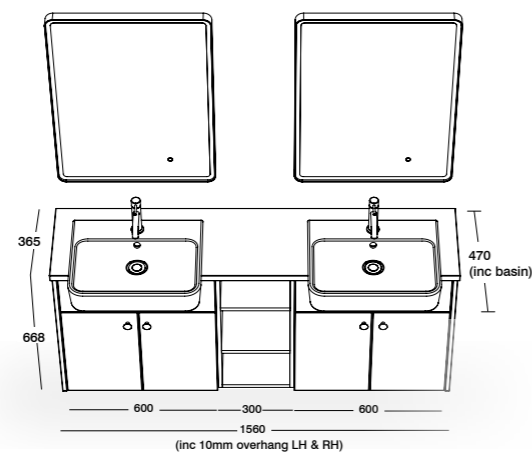

- DOOR: White
- INTERIOR CARCASS: Graphite
- PANELS & PLINTHS: White
- WORKTOP: Strata carrara
- SANITARYWARE: Cover
- TAPS: Craft
- HANDLES: Washington chrome
- MIRROR: 600mm Frame

- WALL TILES: mandarinstone.com
- FLOOR TILES: mandarinstone.com

TAILOR YOUR LOOK

The natural stone-like beauty of Strata carrara solid surface worktops, paired with the simple curves of our Cover sanitaryware create a distinctly contemporary look & feel.



PAGE 80 Cover basin



PAGE 66 Washington chrome handle



PAGE 74 Craft tap



PAGE 97 600mm Frame mirror



Simple, Understated Style

VETRO

High-gloss doors offer contemporary edge with a striking, glass-like finish. Available in 2 shades.



apex



VETRO UNITS
HAVE A HARD
WEARING
GLOSS FINISH

Unique Furniture
VETRO LIGHT GREY

Bring elegance and warmth into your bathroom with our enduring on-trend light grey with a two-tone silver edge creating the illusion of a glass-faced finish.

Go for a really contemporary installation by combining with the Accent basin and wall mounting your unit instead of using plinths and leg sets.

Recommended for use with graphite carcass units.



CREATE THIS LOOK

Want to recreate this look for your new bathroom?

This page shows a helpful floor plan and useful list of items used to design this timeless bathroom.

We offer a free colour swatch service. See page 162 for details.

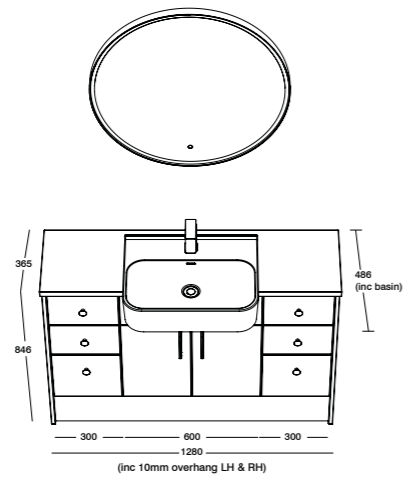

- DOOR: Light grey
- INTERIOR CARCASS: Silver
- PANELS & PLINTHS: Light grey
- WORKTOP: Strata starlight
- SANITARYWARE: Accent
- TAPS: Elate
- HANDLES: Washington & Stockton
- MIRROR: 800mm Frame circular

- WALL TILES: mandarinstone.com
- FLOOR TILES: mandarinstone.com

TAILOR YOUR LOOK

Add to your ultra glossy looking bathroom by pairing with our black on-trend accessories.



PAGE 79 Accent basin



PAGE 66 Washington handle



PAGE 74 Elate tap



PAGE 97 800mm Frame circular mirror

Unique Furniture
VETRO WHITE

Endlessly fresh and clean look to our bright white for a finish which will never go out of fashion.

The thin lines of the Cover basin work perfectly with the contemporary lines of Vetro.

We recommend the use of graphite carcasses with this door finish.



VETRO UNITS
HAVE A HARD
WEARING
GLOSS FINISH



SENSOR
FLUSH BUTTON
UPGRADE
KIT AVAILABLE.
SEE PAGE 85

TAILOR YOUR LOOK

Cool & light, the simple white tones of Vetro white work balance well with the contrast of our black Henley taps.



PAGE 80
Cover basin



PAGE 80
Cover close coupled WC



PAGE 74
Elate basin mixer



PAGE 97
800mm Frame circular mirror

CREATE THIS LOOK

Want to recreate this look for your new bathroom?

This page shows a helpful floor plan and useful list of items used to design this timeless bathroom.

We offer a free colour swatch service. See page 162 for details.

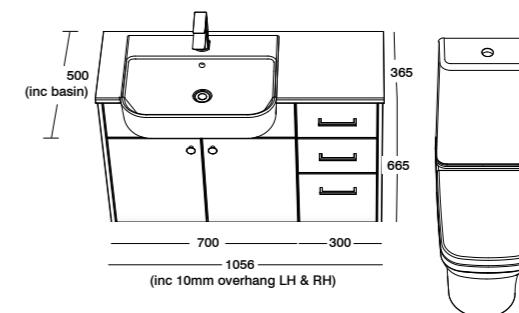

- DOOR: White
- INTERIOR CARCASS: Silver
- PANELS & PLINTHS: White
- WORKTOP: Strata grey quartz
- SANITARYWARE: Cover
- TAPS: Elate
- HANDLES: Washington & Stockton
- MIRROR: 600mm Frame Circular

FLOOR TILES: capietra.com

YOUR PLANNING & ORDERING GUIDE

Now that you have explored the furniture ranges on offer, let us take you through a step by step guide of how to design and create your new fitted furniture bathroom.

01 SELECT A LOOK



TIMELESS

BURFORD



MODERN

ARUBA



UNIQUE

VETRO

The most important choice when determining the look of your bathroom is door style and finish.

We have three stunning furniture styles to choose from; from the timeless looking Burford; pared-back modern style of Aruba or the glass-like contemporary edge of Vetro.



We also offer a free colour swatch service. See page 162 for details.



* Standard depth 353mm

* Slim depth 218mm

(* excludes worktop & basin)

02 CHOOSE YOUR DEPTH OF UNIT

Assess the available space in your bathroom and choose from either standard depth (353mm) or space-saving slim depth (218mm) units. Consider which combination of units work for the space of your bathroom.

03 HANDLE OPTIONS

Add the perfect finishing touch to your doors with one of our range of handles. Choose from chrome, brass, matt black, bronze or colour matched options. See pages 66-67 for our full range.



04 WORKTOP OPTIONS



LAMINATE



SOLID SURFACE



INTEGRATED BASIN & WORKTOP

Select a worktop from either our Strata solid surface or laminate options. Alternatively opt for either the solid surface City underslung basin or Motif semi-recessed basin. Both have an integrated worktop for a seamless look which works equally well with both contemporary and classic bathroom designs. See pages 68-73 for further details.

05 BASIN & WCs



Choose your preferred basin and WC to match the styling of your bathroom, in addition to a cistern and frame (if required). Complete the look by selecting from our range of flush plate options on page 85.

06 TAPS



Top your basin with our expert-engineered and stylish basin mixers. See pages 74-75 for our full range of options.

07 MIRRORS & CABINETS



Choose your preferred mirror or cabinet from pages 88-113. Maybe add some useful wall cupboards for extra storage, see pages 127-131.

08 PANELS, PLINTHS & BATH PANELS

All of our fitted furniture ranges can be wall hung or floor mounted, depending on your desired look. If you opt for floorstanding units, you will need to order colour matched plinths in order to hide the leg supports. All carcasses and panels are unmatching.

Design panels can also be used between units to achieve a framed effect. See pages 138-141.

Finally, choose your bath panel to keep everything coordinated. See page 142.



DON'T FORGET YOUR END PANELS COLOUR-MATCHED TO COMPLETE YOUR FURNITURE

Adding the finishing touches

HANDLE COLLECTION

We have a comprehensive offer of handles & door knobs to complement our furniture. From curved & rounded to sleek & contemporary.

Choose the handle that best reflects your chosen bathroom style. More information on our handle options can be found on pages 132-133.

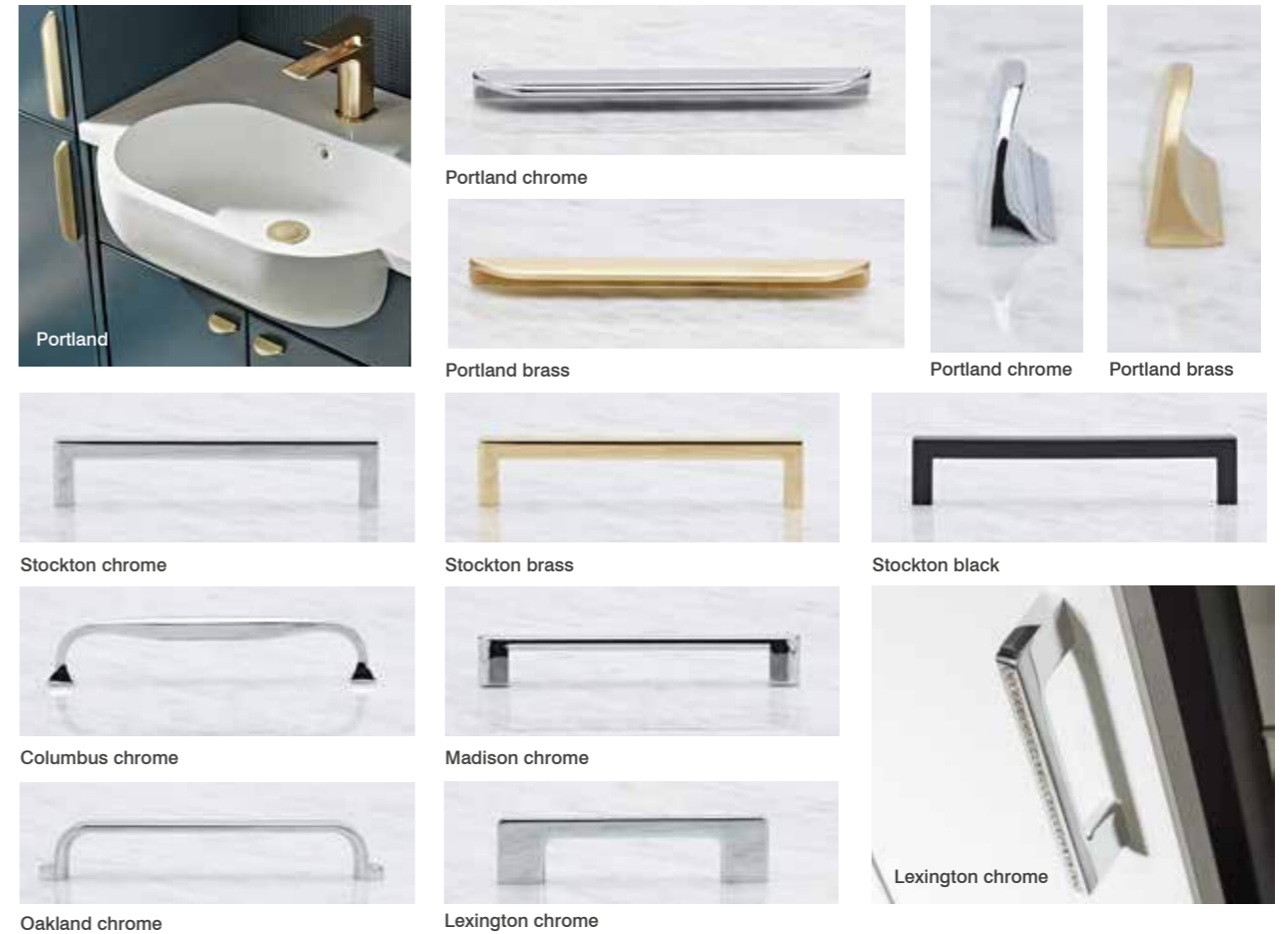
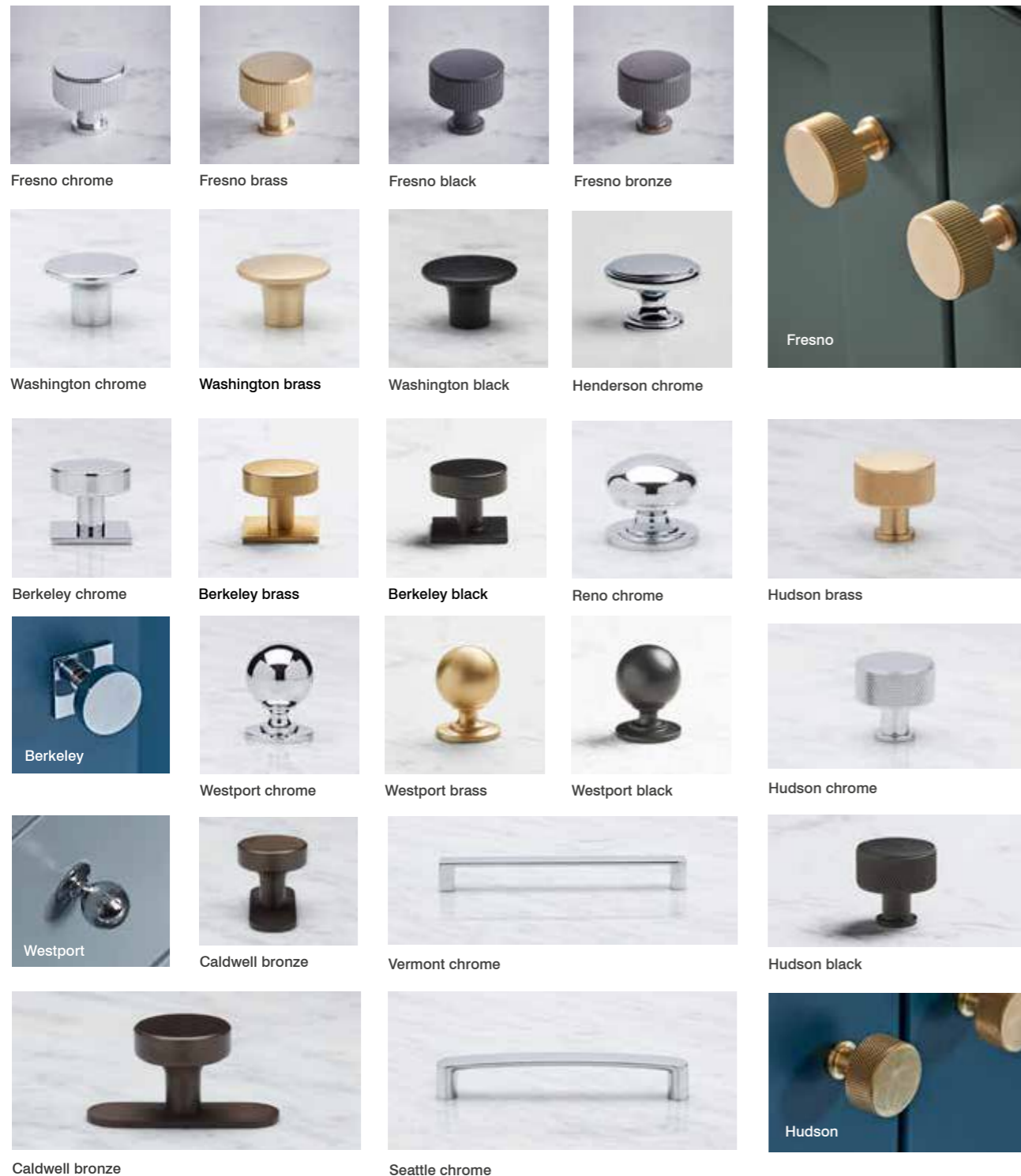

CATALINA COLOUR MATCHED HANDLES

Handle	Compatible Unit Colour
SCHH09W.150	Gloss White, Vetro White, Alpine Elm
SCHH09MCB.150	Mercury, Flintwood, Charcoal Elm
SCHH09JNP.150	Juniper
SCHH09GDC.150	Gloss Dark Clay
SCHH09LG.150	Vetro Light Grey, Powder Grey
SCHH09DB.150	Derwent Blue
SCHH09BK.150	Black



KANSAS CHROME HANDLE USAGE

Unit	Handle	Code	No. Required
200 Cupboard Door Pack	197mm	FHKAN20.C	1
200 Toilet Roll Holder Door	197mm	FHKAN20.C	1
300 Cupboard Door Pack	297mm	FHKAN30.C	1
300 Triple Drawer Fascia Pack	297mm	FHKAN30.C	3
300 FHU Twin Door Pack	297mm	FHKAN30.C	2
400 Cupboard Door Pack	397mm	FHKAN40.C	1
500 SCT Unit Fascia Pack	247mm	FHKAN25.C	2
600 SCT Unit Fascia Pack	297mm	FHKAN30.C	2
700 SCT Unit Fascia Pack	347mm	FHKAN35.C	2



Adding the finishing touches

WORKTOP OPTIONS

The choice is yours with our diverse collection of worktop finishes, materials & styles.

Recreate the depth of natural stone with our strata solid surface worktops, or choose one of our high quality, durable laminate surfaces. For a modern take on hardwearing worktops, choose our compact grade laminate combined with subtle underslung basin. Or go contemporary with the smooth, uninterrupted finish of our integrated worktop and basin.



Strata solid surface



City basin



Laminate



Compact grade laminate

STRATA SOLID SURFACE WORKTOPS

Strata worktops are an ideal solution for those wishing for an aspirational look & the feel of solid surface. The natural stone-like beauty of Strata solid surface makes them a perfect choice for your bathroom.

Strata worktops are completely solid and can be cut to whatever size or shape your bathroom demands, with no need to bond on finishing strips. Simply cut to the desired profile and sand down the end to a fine finish. Adhesive is also available for joining longer runs or corner installations.

As with any solid surface product, darker finishes will show some scratches over time, however these can be very easily sanded and polished out to keep your worktop in pristine condition.

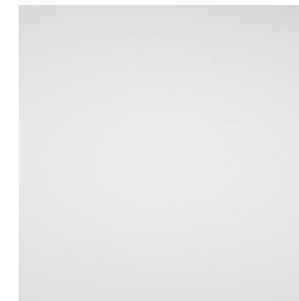

Arctic White



Ice White



Carrara



Grey Quartz

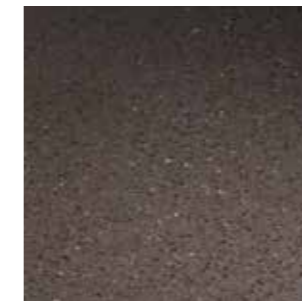

Stone Grey



Galactic Black

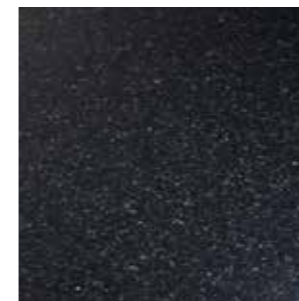

Starlight

10
YEAR

GUARANTEE
10 year guarantee

Adding the finishing touches

BASINS WITH INTEGRATED WORKTOPS

Expertly moulded into a single piece, our basins with integrated worktops strike the perfect balance between form & function. Choose from the City basin or opt for the semi-recessed Motif basin style for a clean, minimalist look.

CITY BASIN

The natural beauty of the solid surface worktop flows effortlessly into the deep, spacious wash basin.

Provided in 1640mm length, the worktop can be cut down to size to suit your installation and finished so that exposed ends can be visible. To be used with 600mm semi-countertop units only, with a maximum furniture run of 1620mm including end panels. It works equally well with both classic and contemporary bathroom designs.

See page 135 for further details.



MOTIF BASIN

The Motif basin is available in 1640mm length and the worktop can be cut down to size to suit your installation and finished so that exposed ends can be visible. Available in standard or slim depths and left or right handed versions.

Motif is to be used with 600mm semi-countertop units only, with a maximum furniture run of 1620mm including end panels. It works equally well with both classic and contemporary bathroom designs.

See page 135 for further details.



GUARANTEE
20 year guarantee

Adding the finishing touches

COMPACT GRADE LAMINATE WORKTOPS

Discover our selection of super hardwearing, compact grade laminate worktops.

These worktops boast an impact resistant surface made from hygienic, fully waterproof material, making them a perfect, low maintenance option for the busy family bathroom. Available in three chic finishes, with a slim 12mm profile. Compact grade laminate worktops can also be cut to any length, without the need to reseal.

Exclusively designed to work with our 600mm underslung basin unit (page 118).



Grey Slate



White Slate



Concrete



Grey slate

LAMINATE WORKTOPS

High quality & durable, our range of laminate worktops will add style to your bathroom.

Specifically chosen to complement our extensive range of door & unit colours, a little inspiration will allow you to use the worktops in imaginative ways to create a striking effect.



Massa Marble



Portland Stone



White



White Sparkle



Natural Oak



Isadora Stone



Riven Slate

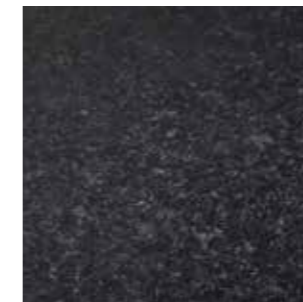

Black Granite



Black Sparkle

Adding the finishing touches

TAP COLLECTION

Designed to deliver the finishing touch to your bathroom, our basin mixers are not only beautiful to look at but superbly well engineered for durability too.

From ultra contemporary to more timeless designs, there is something to suit everyone. Many ranges include a mini basin mixer option, very useful for slim depth basins. Most taps also have a coordinating bath filler. Please refer to the main Roper Rhodes Bathroom Book for more information.

All Roper Rhodes taps use the latest highly reliable ceramic cartridge and ceramic disc technology. Our brushed brass taps include a hardwearing and scratch resistant PVD coating. As testament to this in-built quality, all of our taps are provided with a ten year guarantee.



10 YEAR
GUARANTEE
10 year guarantee
including tap cartridge

STORM-NOVA *apex*

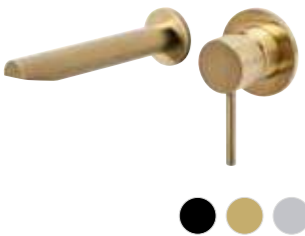

Storm-Nova wall mounted basin mixer
160(w) x 120(h) x 180mm(d)
Minimum operating pressure 0.2bar

Chrome	T491902	£170.30
Black	T491903	£225.00
Brushed Brass	T491904	£270.00



Storm-Nova basin mixer with click waste
42(w) x 158(h) x 136mm(d)
Minimum operating pressure 0.2bar

Chrome	T461102	£170.30
Black	T461103	£210.10
Brass Brass	T461104	£255.30

METRIC *apex*



Metric basin mixer with click waste
52(w) x 160(h) x 160mm(d)
Minimum operating pressure 0.2bar

Chrome	T391102	£210.10
Black	T391103	£249.90
Brushed Brass	T391104	£275.00

CRAFT



Craft wall mounted basin mixer
160(w) x 120(h) x 205mm(d)
Minimum operating pressure 0.2bar

Chrome	T331902	£192.60
--------	---------	---------



Craft basin mixer with click waste
56(w) x 164(h) x 165mm(d)
Minimum operating pressure 0.2bar

Chrome	T331102	£202.60
--------	---------	---------

HYDRA



Hydra basin mixer with click waste
50(w) x 157(h) x 158mm(d)
Minimum operating pressure 0.2bar

Chrome	T151102	£212.30
Black	T151103	£212.30
Brushed Brass	T151104	£212.30

Please note: Black & Brushed Brass finishes are only available for the Hydra basin mixer with click waste.

ELATE



Elate basin mixer with click waste
53(w) x 150(h) x 175mm(d)
Minimum operating pressure 0.5bar

Chrome	T241102	£241.80
Black	T241103	£241.80
Brushed Brass	T241104	£241.80

Please note: Black & Brushed Brass finishes are only available for the Elate basin mixer with click waste.

SCAPE



Scape basin mixer with click waste
58(w) x 165(h) x 158mm(d)
Minimum operating pressure 0.2bar

Chrome	T351102	£202.60
--------	---------	---------

CLEAR



Clear basin mixer with click waste
54(w) x 173(h) x 160mm(d)
Minimum operating pressure 0.2bar

Chrome	T361102	£202.60
--------	---------	---------

SIGN



Sign open spout basin mixer with click waste
55(w) x 175(h) x 150mm(d)
Minimum operating pressure 1.0bar

Chrome	T171102	£228.90
--------	---------	---------

SYNC



Sync basin mixer with click waste
52(w) x 150(h) x 155mm(d)
Minimum operating pressure 0.5bar

Chrome	T201102	£201.00
--------	---------	---------

STORM



Storm basin mixer with click waste
58(w) x 155(h) x 149mm(d)
Minimum operating pressure 0.1bar

Chrome	T221002	£169.30
--------	---------	---------

WESSEX



Wessex basin mixer with click waste
218(w) x 275(h) x 180mm(d)
Minimum operating pressure 0.1bar

Chrome	T661002	£273.00
--------	---------	---------

CRANBOURNE



Cranbourne basin mixer with click waste
190(w) x 192(h) x 170mm(d)
Minimum operating pressure 0.2bar

Chrome	T311102	£202.60
--------	---------	---------

KESWICK



Keswick basin mixer with click waste
168(w) x 200(h) x 160mm(d)
Minimum operating pressure 0.2bar

Chrome	T321102	£202.60
Brushed Brass	T321104	£285.00

HENLEY



Henley basin mixer with pop up waste
224(w) x 117(h) x 167mm(d)
Minimum operating pressure 0.1bar

Chrome	T261102	£201.50
--------	---------	---------



For matching mini basin mixers, bath fillers and bath shower mixers, please see our Bathroom Book or visit roperrhodes.co.uk





Meet the WC & basin
DESIGNERS

Discover style in every corner of the bathroom with our collection of fine ceramics, all designed by our specialist product designers.

Contemporary forms combine with their expert know-how to give you the best selection of stylish and practical basins, WCs and flushing solutions.

WCs & BASINS

PARADIGM COLLECTION



RIMLESS DESIGN
All Paradigm WCs are hygienic, easy to clean and benefit from rimless technology



475mm standard depth semi-countertop basin
DC14029 **£167.10**



475mm slim depth semi-countertop basin
DC14028 **£142.90**



Back to wall WC & soft close seat
PBWPAN **£275.20**
DC14030 **£102.80**



Wall hung WC & soft close seat
PWHPAN **£275.20**
DC14030 **£102.80**



Fully enclosed close coupled WC & soft close seat *
PCCPAN **£316.00**
DC14035 **£105.70**
DC14030 **£102.80**



Close coupled WC & soft close seat *
PCCPAN2 **£285.90**
DC14035 **£105.70**
DC14030 **£102.80**



Optional black or brushed brass flush button upgrade ø48mm
For use with Paradigm close coupled cisterns
Black TR9027 **£18.30**
Brushed brass TR9039 **£23.00**



Cover caps upgrade
For use with Paradigm seats
Black DC4019 **£18.30**
Brushed brass DC4020 **£31.70**

ACCENT COLLECTION



Back to wall WC & soft close seat
ABWPAN **£459.00**
ASCTS **£109.10**



Wall hung WC & soft close seat
AWHPAN **£459.00**
ASCTS **£109.10**



560mm standard depth semi-countertop basin
A3SCBAS **£364.40**



550mm slim depth semi-countertop basin
A2SCBAS **£344.00**



Cover caps upgrade
For use with Accent seat ASCTS
Black DC4019 **£18.30**
Brushed brass DC4020 **£31.70**

*Close coupled WC Spigot distance from wall 150mm

COVER COLLECTION



Contactless flushing
Our Cover close coupled WC is available with a contactless flush.



560mm standard depth semi-countertop basin

C3SCBAS £277.30



560mm slim depth semi-countertop basin

C2SCBAS £261.20



Back to wall WC & soft close seat

CBWPAN-R £459.00
CSCTS £109.10



Wall hung WC & soft close seat

CWHPAN-R £459.00
CSCTS £109.10



Cover caps upgrade
For use with Cover seat CSCTS-SF

Black DC4023 £18.30
Brushed brass DC4024 £31.70



Optional black or brushed brass basin overflow caps
For use with Cover semi-countertop basins

Black OVMCBK £10.00
Brushed brass OVMCA £10.00



Close coupled fully enclosed WC & seat *

CCCPAN-R £459.00
CCCTNK-R £221.90
CSCTS £109.10



Close coupled fully enclosed WC & seat with contactless flush *

CCCPAN-R £459.00
CCCTNK-R-SEN £335.40
CSCTS £109.10



Optional black or brushed brass flush button upgrade ø38mm
For use with Cover close coupled cisterns

Black TR9026 £18.30
Brushed brass TR9038 £23.00

NOTE COLLECTION



560mm standard depth semi-countertop basin

N3SCBAS £385.90



540mm slim depth semi-countertop basin

N2SCBAS £365.50



Back to wall WC & slim soft close seat

NBWPAN £553.60
NSLSCTS £116.60

STANDARD SEAT AVAILABLE 8704WSC



500mm wall hung WC & slim soft close seat

NWHPAN £553.60
NSLSCTS £116.60

STANDARD SEAT AVAILABLE 8704WSC



Standard soft close toilet seat

8704WSC £80.40



Optional black or brushed brass basin overflow caps
For use with Cover semi-countertop basins

Black OVMCBK £10.00
Brushed brass OVMCA £10.00



Cover caps upgrade
For use with Note soft close NSLSCTS slim soft close seat only

Black DC4023 £18.30
Brushed brass DC4024 £31.70



WCs & Basins
ZEST COLLECTION



560mm standard depth semi-countertop basin
Z3SCBAS £368.70



435mm slim depth semi-countertop basin
Z2SCBAS £324.60



450mm back to wall WC & soft close seat
ZBWPAN45 £376.20
ZSCTS45 £197.80



500mm back to wall WC & soft close seat
ZBWPAN50 £403.10
ZSCTS50 £197.80



500mm wall hung WC & soft close seat
ZWHPAN50 £443.90
ZSCTS50 £197.80

WCs & Basins
GEO COLLECTION



Contactless flushing
Our Geo close coupled WCs are available with a contactless flush.



515mm standard depth semi-countertop basin
G3SCBAS £245.60



540mm slim depth semi-countertop basin
G2SCBAS £226.20



Back to wall WC & soft close seat
GBWPAN £281.60
GSCTS-SF £108.00

Secure-Fix QR



Optional black or brushed brass basin overflow caps
For use with Geo semi-countertop basins
Black OVMCBK £10.00
Brushed brass OVMCA £10.00



Close coupled fully enclosed WC *
GCCPAN £370.80
GCCTNK £156.40
GSCTS-SF £108.00

Secure-Fix QR



Close coupled fully enclosed WC with contactless flush *
GCCPAN £370.80
GCCTNK-SEN £268.70
GSCTS-SF £108.00

Secure-Fix QR



Open back close coupled WC *
GCCPAN2 £336.40
GCCTNK £156.40
GSCTS-SF £108.00

Secure-Fix QR



Open back close coupled WC with contactless flush*
GCCPAN2 £336.40
GCCTNK-SEN £268.70
GSCTS-SF £108.00

Secure-Fix QR



Optional black or brushed brass flush button upgrade ø38mm
For use with Geo close coupled cisterns
Black TR9026 £18.30
Brushed brass TR9038 £23.00

*Fully enclosed WC Spigot distance from wall 220mm - Open back WC Spigot distance from wall 200mm

HARROW COLLECTION



550mm standard depth semi-countertop basin 1 tap hole
SCSB850S £199.90



550mm standard depth semi-countertop basin 2 tap hole
SCDB850S £199.90



Back to wall WC & soft close seat
BTW850S £251.50
HSCTSW £122.00



Close coupled WC & soft close seat
HCCPAN £199.90
HCCTNK £165.00
HSCTSW £122.00



Solid oak soft close seat
For use with Harrow WCs
HSCTSNO £136.50

Flushing Solutions

FLUSH PLATES

Whether you need a contemporary or traditional look, we have flush plates to suit. Compatible for use with our wall hung frames or as an optional upgrade for cisterns



Plaza dual flush push plate
210(w) x 137mm(h)
Black TR9020 £61.00



Plaza dual flush push plate
210(w) x 137mm(h)
Brushed brass TR9036 £99.40



Plaza dual flush push plate
210(w) x 137mm(h)
Chrome TR9010 £49.70



Plaza dual flush push plate
210(w) x 137mm(h)
Stainless Steel TR9019 £118.20



Rondo dual flush push plate
210(w) x 137mm(h)
Black TR9021 £61.00



Rondo dual flush push plate
210(w) x 137mm(h)
Brushed brass TR9037 £99.40



Rondo dual flush push plate
210(w) x 137mm(h)
Chrome TR9012 £49.70



Glass flush push plate
210(w) x 137mm(h)
Black TR9029 £141.90



Ellipse dual flush push plate
210(w) x 142mm(h)
Chrome TR9004 £49.70



Traditional flush push plate
210(w) x 137mm(h)
Chrome TR9017 £57.20

CLOSE COUPLED SENSOR FLUSH KITS

With a simple wave of the hand, hygienic, contactless flushing is now here for close coupled WCs. Two sizes are available depending on the size of the flush button hole in the cistern lid. The button kits have been designed to retro-fit to existing WCs which have paddle operated flush valves. For cisterns which have pneumatic or cable operated flush valves, or where the button screws in directly to the flush valve, then the flush valve will also need to be swapped to our TR9033 valve which has a 2" base.



Alternatively, you can purchase your new close coupled WC cistern with the sensor flush kit included.

Note: Paradigm WCs are currently incompatible with the flush sensor kits.

OPTIONAL UPGRADES FOR CONCEALED CISTERNS

Designed to work with furniture back to wall WC units. Optional upgrades for torrent cisterns.



Square dual flush button
72(w) x 72mm(h)
Black TR9028 £23.00
Brushed Brass TR9035 £46.00
Chrome TR9003 £18.30



Round dual flush button
72(w) x 72mm(h)
Black TR9022 £23.00
Brushed brass TR9034 £46.00



Oval flush button*
140(w) x 80mm(h)
Chrome TR9023 £62.80
Black TR9040 £78.50

* Not compatible with Comfort Cistern
* when used in Slim Depth furniture



ø38mm close coupled sensor flush button kit
TR9031 £86.30



ø48mm close coupled sensor flush button kit
TR9032 £86.30



Close coupled flush valve 2" base
TR9033 £27.60

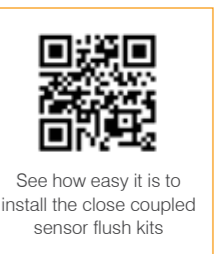

See how easy it is to install the close coupled sensor flush kits

Flushing Solutions

FLUSHING SOLUTIONS

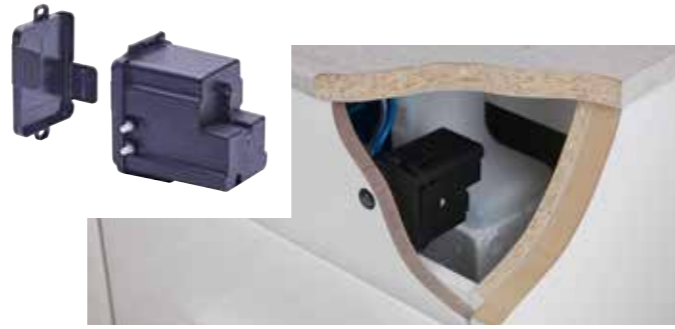

CONTACTLESS DUAL FLUSH SENSOR

- Provides a touchless flush, with just the wave of a hand
- Best used with concealed cisterns in furniture
- Powered by 4 x AA batteries
- Low battery power alarm, battery life in excess of 1 year (normal domestic conditions, good quality batteries)
- Dual flush
- Discreet decal included to indicate sensor location
- Works through surfaces up to 25mm thick (including ceramic tiles, fascias & worktops)



SENSOR VIDEO
See how easy it is to use & maintain the sensor



Contactless dual flush sensor use with concealed cisterns

Sensor kit	TR9014	£158.50
------------	--------	---------

CONTACTLESS SENSOR DUAL FLUSH PLATE

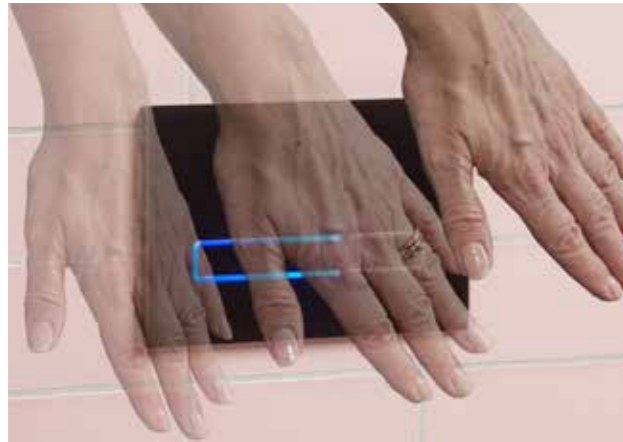

- Recommended for in-wall installations
- Contactless flushing
- Powered by 4 x AA batteries (easy to change, no tools required)
- Low battery power alarm (battery life in excess of 1 year)
- Dual flush
- Manual override flush
- Illuminates on operation
- Use on wall hung frames and In-wall cistern (not compatible with slim depth furniture)

Contactless sensor flush plate
210(w) x 137(h)mm

Black	TR9025	£177.30
-------	--------	---------

TOUCH OPERATED SENSOR DUAL FLUSH PLATE



- Recommended for furniture or lower height installations
- Touch operated to prevent inadvertent use
- Powered by 4 x AA batteries (easy to change, no tools required)
- Low battery power alarm (battery life in excess of 1 year)
- Dual flush
- Manual override flush
- Illuminates on operation
- Use on wall hung frames and In-wall cistern (not compatible with slim depth furniture)

Touch operated sensor flush plate
210(w) x 137(h)mm

Black	TR9016	£177.30
-------	--------	---------



SENSOR VIDEO
See how easy it is to use & maintain the sensor

Concealed Cisterns

WALL HUNG WC FRAMES & CONCEALED CISTERNS

Made with efficiency and functionality in mind, our cisterns and frames are designed to offer the maximum performance while keeping the layout of your bathroom clean and uncluttered.



1.17M wall hung WC frame
500(w) x 1168(h) x 140 - 200mm(d)
6/3 litres

1.17m frame	TR9006	£322.50
-------------	--------	---------

Use for in-wall applications, includes fittings, requires flush plate/button, or contactless sensor (available separately). Air Gap inlet valve. 200mm height adjustment.



1.0M wall hung WC frame
500(w) x 1000(h) x 167 - 215mm(d)
6/3 litres

1.0m frame	TR9015	£322.50
------------	--------	---------

Ideal for boxed in applications, especially under windows. Requires flush plate/button, or contactless sensor (available separately). Air Gap inlet valve. 200mm height adjustment.



0.82 wall hung WC frame
500(w) x 820(h) x 167 - 215mm(d)
6/3 litres

0.82m frame	TR9005	£322.50
Furniture Adaptor Kit	TR9007	£55.20

Can be used with 600mm and wider furniture WC units. Use with Furniture Adaptor Kit, requires flush plate/button, or contactless sensor (available separately). Air Gap inlet valve. 200mm height adjustment.



0.4M WC / bidet frame
400(w) x 400(h) x 170 - 335mm(d)

0.4m frame	TR9018	£149.40
------------	--------	---------

Compact half height WC frame suitable for use in narrow back to wall units including 500mm wide. For use with Torrent, Cascade or comfort height cisterns. Can also be used for bidets. Air Gap inlet valve. 200mm height adjustment.



6/3L in-wall cistern
600(w) x 745max(h) x 138-194(d)mm

TR9009	£147.80
--------	---------

Ideal for tiled in applications. All parts serviceable through flush plate aperture.

Internal isolation valve, 150mm height adjustment. Air Gap inlet valve. Top or front flush plate mounting. 1/2" BSP. Requires flush plate/button, or contactless sensor (available separately).



6/3L Comfort height cistern
with chrome flush button
437(w) x 324(h) x 165(d)mm

TR9008	£130.00
--------	---------

Developed specifically to allow comfort height back to wall pans to be used in 820mm high furniture.

Bottom entry inlet valve. Top or front flush plate mounting. 1/2" BSP. PS insulation jacket. Pneumatic flush valve. Optional flush button upgrades available.



6/3L Torrent concealed cistern
with chrome flush button
434(w) x 365(h) x 140(d)mm

TR9001	£130.00
--------	---------

Bottom entry inlet valve. Air Gap inlet valve. Top or front flush plate mounting. 1/2" BSP. PS insulation jacket. Pneumatic flush valve. Optional flush button upgrades available.



6/3L Cascade concealed cistern
with chrome flush button
464(w) x 365(h) x 140(d)mm

TR9002	£130.00
--------	---------

Side entry inlet valve. Top or front flush plate mounting. 1/2" BSP. PS insulation jacket. Pneumatic flush valve. Optional flush button upgrades available.



Meet the mirror & cabinet

DESIGNERS

Our product designers are experts in creating mirrors and cabinets that offer style and substance. With a whole host of ingenious features, their brief is always to make your morning routine as seamless as possible.

Find all the features you need in a style you love with our wide range of shapes, sizes and finishes. Plus, mirrors and cabinets specifically designed to coordinate with your furniture are also available to give you an effortlessly cohesive look.

MIRRORS & CABINETS

Discover

ROPER RHODES MIRRORS & CABINETS

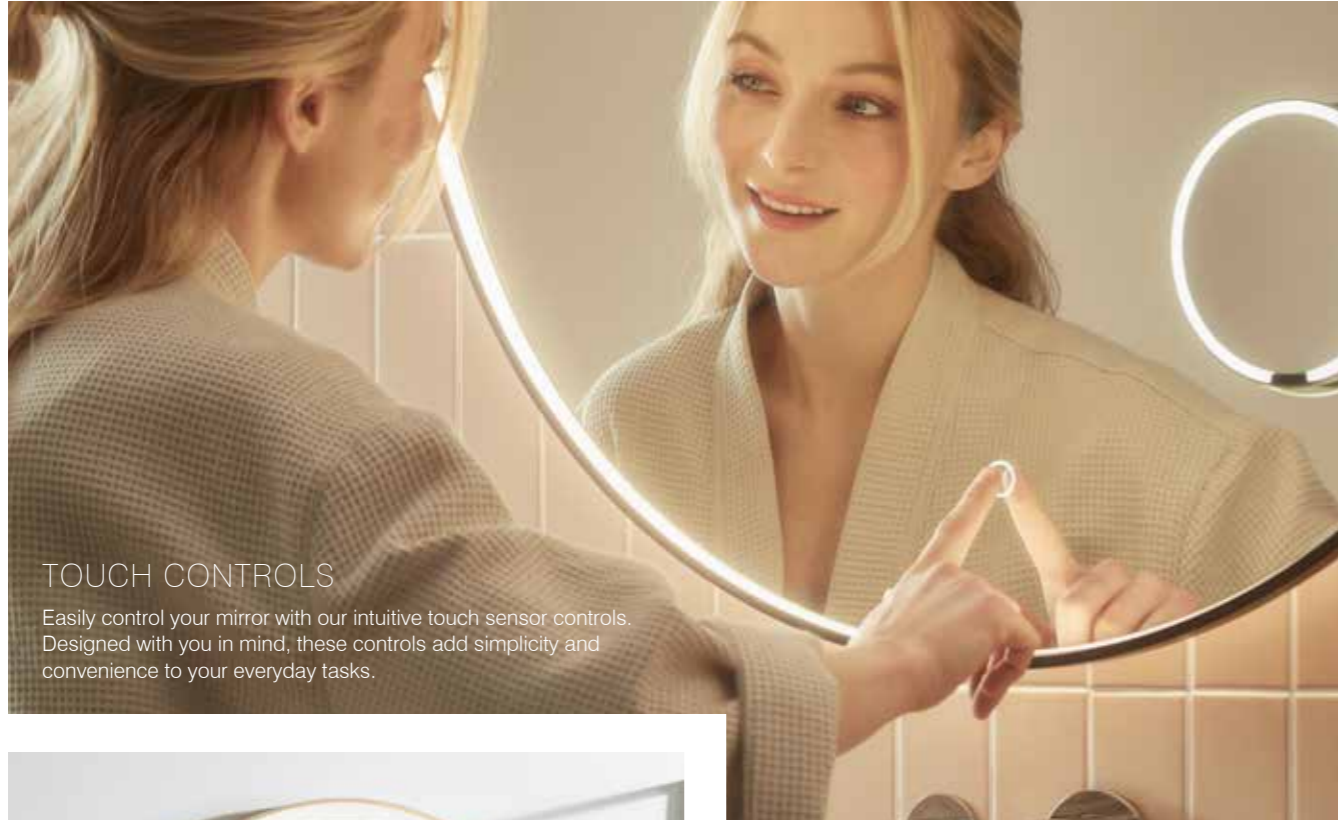

TOUCH CONTROLS

Easily control your mirror with our intuitive touch sensor controls. Designed with you in mind, these controls add simplicity and convenience to your everyday tasks.



GUARANTEES

At Roper Rhodes, we pride ourselves in offering high quality products that are built to last, even in the hectic and high traffic space that is the bathroom.

CHARGING SOLUTIONS

Discover true convenience with our range of charging enabled mirrors and cabinets. Sleekly designed hidden sockets are perfect for tooth brushes or razors. Plus, wireless charging is available in our Boost cabinet (page 107), perfect for charging your phone when you're busy getting ready.



6000K

Cool to warm

2700K



FIND YOUR PERFECT LIGHT

Transform your space with ingenious colour changing technology. Invigorate your morning with bright, crisp daylight. Or wrap yourself in a soft, warm glow and as you spend an hour relaxing in the bath. With a wide spectrum LED ranging from 2700-6000K, you can easily shift your mirror lighting from cool white to warm and intimate at the simple touch or wave of the hand.

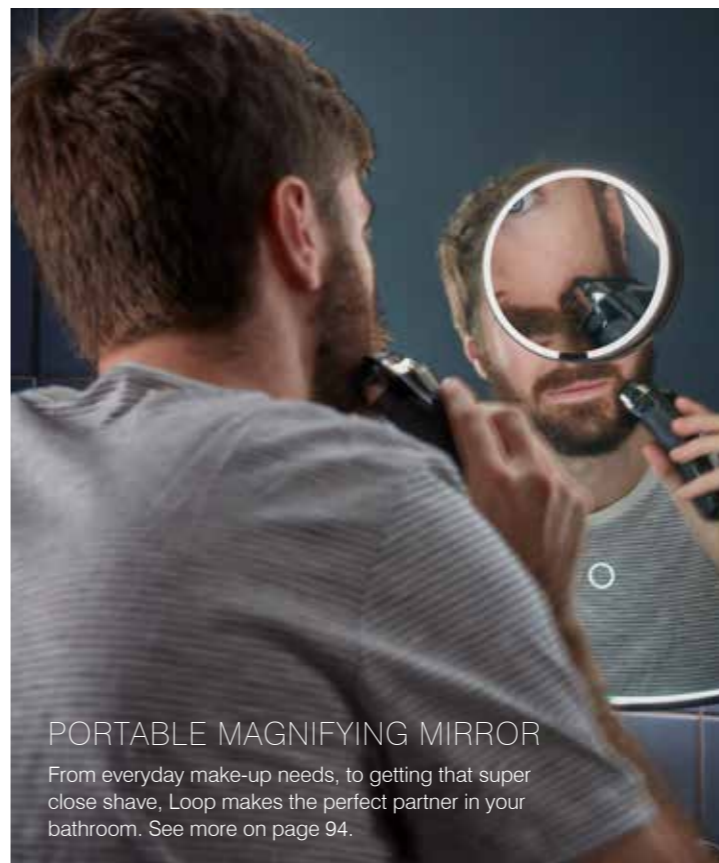

PORTABLE MAGNIFYING MIRROR

From everyday make-up needs, to getting that super close shave, Loop makes the perfect partner in your bathroom. See more on page 94.



PLAY MUSIC IN YOUR BATHROOM

Pump up your morning routine with our **Bluetooth®** enabled mirrors. Seamlessly connect your phone to get the music going and start your day off right. Discover more with our Play mirror on page 96.

Making the perfect choice

MIRROR & CABINET FEATURES & BUYING GUIDE

Use the table below to guide you around our mirror & cabinet collection and help you find the features which are important to you when selecting your new mirror or cabinet.

	LED lighting	Variable warm to cool & dimmable LEDs	Infrared sensor	Touch controls	Heated demister	Bluetooth® wireless technology	Two-pin charging socket	USB charging socket	USB-C charging socket	Wireless charging	Magnifying mirror	Slim depth	Landscape & portrait	Recessible or Recessed	Soft close doors	Double sided mirror doors	Push to open doors	IP44 or IP55 rated
MIRRORS																		
Loop	●	●	●	●							●	●						●
Play	●	●	●	●	●	●						●	●					●
Frame	●	●	●		●								●					●
Eminence	●	●	●		●								●					●
Academy	●	●		●	●							●	●					●
Leap	●		●		●		●	●					●					●
Thesis													●					
Scheme	●	●	●		●													●
System	●	●	●		●							●	●					●
Traditional					●								●					●
CABINETS																		
Origin	●	●	●		●		●	●							●	●		●
Notion	●	●	●		●		●	●	●						●	●	●	●
Boost	●	●	●		●		●	●	●	●		●		●	●	●	●	●
Theory											●				●	●		
Presence	●	●		●	●		●	●							●	●		●
Purpose	●	●		●	●		●	●						●	●	●		●
System	●	●	●		●		●	●							●	●		●



GUARANTEE
10 year guarantee,
against manufacturing
defects



LED LIGHTING
Energy efficient LEDs provide high quality, bright and practical task lighting whilst being 80% more efficient than older fluorescent and incandescent lights



VARIABLE WARM TO COOL & DIMMABLE LEDs
Flexibility to adjust the LED warmth and brightness from an invigorating daylight white (6000K) to a relaxing warm white (2700K)



INFRARED SENSOR
Easy to use, an infrared sensor allows you to control the mirror with just the wave of your hand without touching the mirror



HEATED DEMISTER
Maintain a steam-free mirror reflection in the bathroom with an integrated heated demister pad



PLAY MUSIC
Integrate your favourite music seamlessly into your bathroom



TWO-PIN CHARGING SOCKET
Conveniently positioned, this charging socket keeps your electric toothbrush or shaver fully charged



USB SOCKET
Easily accessed USB socket keeps your devices fully charged



WIRELESS CHARGING BOOST
Perfect for charging your phone/device when you're busy getting ready



SLIM DEPTH
Our slim depth mirrors protrude 30mm or less from the wall



MAGNIFYING MIRROR
Take a closer look magnifying your reflection with our magnifying mirror, 3x magnification



PUSH TO OPEN DOORS
Intuitive push to open mirrored cabinet doors



SOFT CLOSE DOORS
Most of our cabinets feature soft close doors to ensure quiet and controlled closure of the doors



RECESSED OR RECESSIBLE
Recessing the cabinet within the wall is a great way to conceal your bathroom accessories whilst maintaining a clean and clutter free bathroom



DOUBLE SIDED MIRROR DOORS
Double sided mirrored glass means the cabinet mirror can be used when open or closed



IP44 / IP55 RATED
Mirrors indicated with this symbol are IP44 or IP55 rated, making them suitable for use within zone 2 of the bathroom

Vanity mirror accessory

LOOP VANITY MIRROR



- Handheld vanity mirror with 3x magnification
- Compatible with the following mirrors & cabinets
Loop wall mirror p95
Thesis mirrors p101
Notion cabinet p106
Boost cabinet p107
- Supplied with wireless charging stand and USB cable
- Touch control operation.
- Adjustable LED colour temperature & brightness
- IP55 rated



Loop Vanity Mirror	Code	W x H x Dmm	RRP
Vanity Mirror	VM01	140 x 140	£198.80

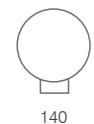

MIRROR VIDEO
Scan to see the Loop mirror features in action

Wall & vanity mirror

LOOP WALL & VANITY MIRRORS

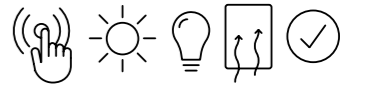

- Wall mirror with detachable Loop vanity mirror, wireless charging stand & USB cable included
- Vanity mirror wireless charging ring on bottom right of large wall mirror
- Touch control operation
- Adjustable LED colour temperature & brightness
- Heated demister pad prevents mirror steaming up
- IP44 rated



ON MIRROR WIRELESS CHARGING & MAGNETIC ATTACHMENT
With the internal magnetic attachment, you can place your Loop vanity mirror anywhere. Set it at the perfect height on your coordinating wall mirror, or place on the dedicated charging ring to keep it powered up.

Loop Wall & Vanity Mirrors	Code	W x H x Dmm	RRP
600 wall mirror & vanity mirror	VMM60C	600 x 600 x 34	£596.60
800 wall mirror & vanity mirror	VMM80C	800 x 800 x 34	£709.50

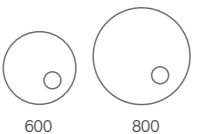

Music in your bathroom
PLAY MIRRORS

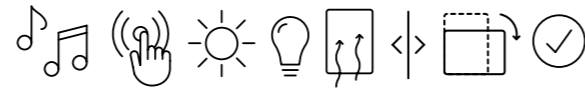

- Seamlessly bring your favourite playlists into your bathroom using **Bluetooth®** Wireless Technology
- Superior resonance speakers.
- Touch control operation
- Adjustable LED colour temperature & brightness
- Heated demister pad prevents mirror steaming up
- Super Slim depth design brings music to your bathroom without compromising style
- IP44 rated

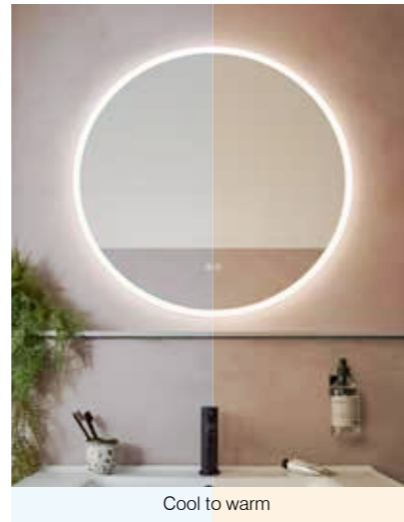

PLAY MUSIC IN YOUR BATHROOM
Bluetooth® Wireless Technology

Play Mirrors	Code	W x H x Dmm	RRP
Circular 600	PYM60C	600dia x 31	£425.70
Circular 800	PYM80C	800dia x 31	£510.60
500 x 700	PYM050	500 x 700 x 31	£425.70

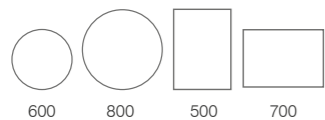

Make a design statement
FRAME MIRRORS

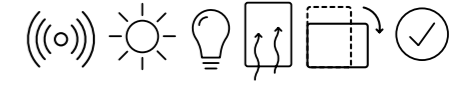

- Aluminium framed mirrors
- Infrared switch controlled by contactless hand movements
- Adjustable LED colour temperature & brightness
- Heated demister pad prevents mirror steaming up
- Available in a brushed brass, black or White finish
- IP44 rated



Frame Mirrors	W x H x Dmm	Brushed Brass	RRP	Black	White	RRP
ø600	ø600 x 38	FR60RB	£399.00	FR60RG	FR60RW	£378.40
ø800	ø800 x 38	FR80RB	£529.00	FR80RG	FR80RW	£507.40
Pill	500 x 800 x 38	-	-	FR50PG	-	£425.70
Oval	500 x 700 x 38	FR50VB	£429.00	FR50VG	-	£397.70
500/700	500 x 700 x 38	-	-	FR50SG	-	£425.70
600/800	600 x 800 x 38	-	-	FR60SG	FR60SW	£507.40
1200	1200 x 600 x 38	-	-	FR120SG	FR120SW	£677.20

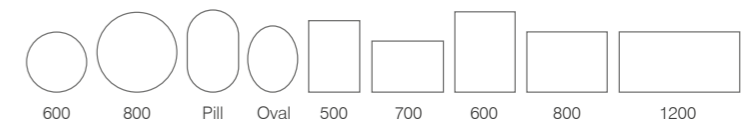

Distinctly modern design
EMINENCE MIRRORS



- Infrared switch controlled by contactless hand movements
- Adjustable LED colour temperature & brightness
- Heated demister pad prevents mirror steaming up
- IP44 rated

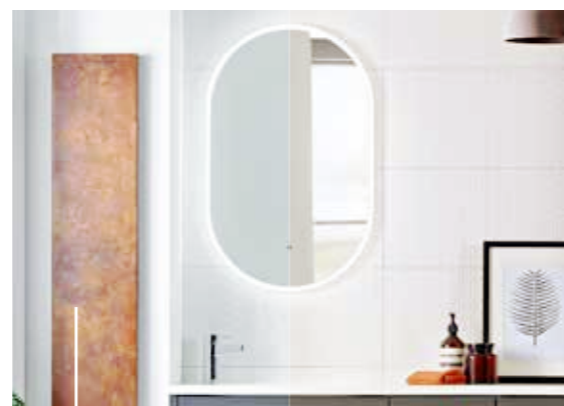

ADJUSTABLE LIGHTING
Cool to warm

Eminence Mirrors	Code	W x H x Dmm	RRP
Circular 550	EM55CAL	550dia x 35	£344.00
Circular 800	EM80CAL	800dia x 35	£434.30
Pill	EM80PAL	500 x 800 x 35	£452.50
Oval	EM65OAL	490 x 650 x 35	£385.90
500/700	EM70RAL	500 x 700 x 35	£493.40
600/800	EM80RAL	600 x 800 x 35	£513.80

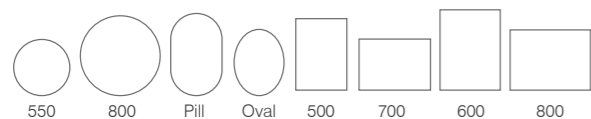

Intuitive design
ACADEMY MIRRORS

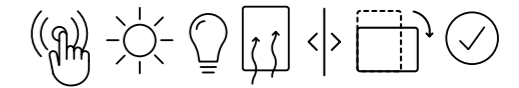

- Adjustable LED colour temperature & brightness
- Intuitive slide controls
- Heated demister pad prevents mirror steaming up
- Slim depth design
- IP44 rated

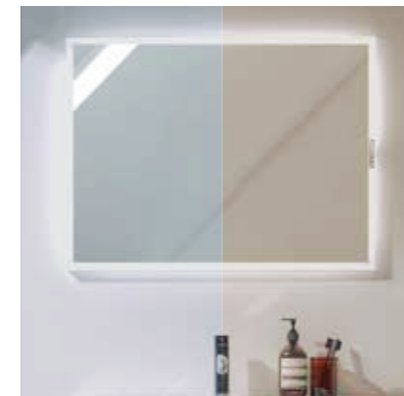

ADJUSTABLE LIGHTING
Cool to warm



TOUCH CONTROLS
switch between functions,
slider controls warmth or brightness



Academy Mirrors	Code	W x H x Dmm	RRP
500/700	ACM050	500 x 700 x 25	£441.80
600/800	ACM060	600 x 800 x 25	£480.50
1000	ACM100	1000 x 600 x 25	£529.90

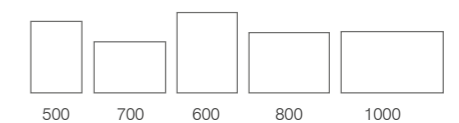

Functional design

LEAP MIRRORS



- Infrared switch controlled by contactless hand movements
- Heated demister pad prevents mirror steaming up
- Built in two-pin charging socket for your shaver or toothbrush
- Additional USB charging socket.
- IP44 rated



CHARGING & USB SOCKET
Built into the mirror for your convenience

Leap Mirrors	Code	W x H x Dmm	RRP
500/700	LE70ALU	500 x 700 x 55	£513.80
600/800	LE80ALU	600 x 800 x 55	£537.50
1200	LE120ALU	1200 x 600 x 55	£677.20

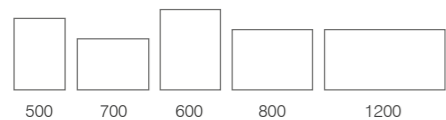

Designer edge

THESIS MIRRORS



- Framed with a high quality aluminium trim in a brushed brass or black finish
- Rectangular versions can be mounted landscape & portrait
- Compatible with the Loop vanity mirror see page 94 for details
- Can be purchased with or without the Loop vanity mirror

BRUSHED BRASS
Frame finish



BLACK
Frame finish



LOOP VANITY MIRROR BUNDLE
The Thesis mirrors can be purchased as part of a bundle with the Loop vanity mirror, see below for pricing details. Further details on the Loop vanity mirror can be found on page 94.



Thesis Mirror	W x H x Dmm	Black	RRP	Brushed Brass	RRP	Thesis Bundle	Black	RRP
ø600	ø600 x 38	TNM60C	£135.40	TNM60C-BR	£149.00	ø600 & Loop	TNM60C-VM	£317.10
ø800	ø800 x 38	TNM80C	£191.80	TNM80C-BR	£209.00	ø800 & Loop	TNM80C-VM	£374.10
Pill	500 x 800 x 38	TNM50P	£180.60	-	-	Pill & Loop	TNM50P-VM	£362.20
Oval	500 x 700 x 38	TNM50V	£169.30	TNM50V-BR	£189.00	Oval & Loop	TNM50V-VM	£350.40
450/700	450 x 700 x 38	TNM045	£146.70	-	-	450/700 & Loop	TNM045-VM	£327.80
600/800	600 x 800 x 38	TNM060	£180.60	-	-	600/800 & Loop	TNM060-VM	£362.20



Linear lighting, angular design
SCHEME MIRRORS



- Infrared switch controlled by contactless hand movements
- Adjustable LED colour temperature & brightness
- Heated demister pad prevents mirror steaming up
- IP44 rated

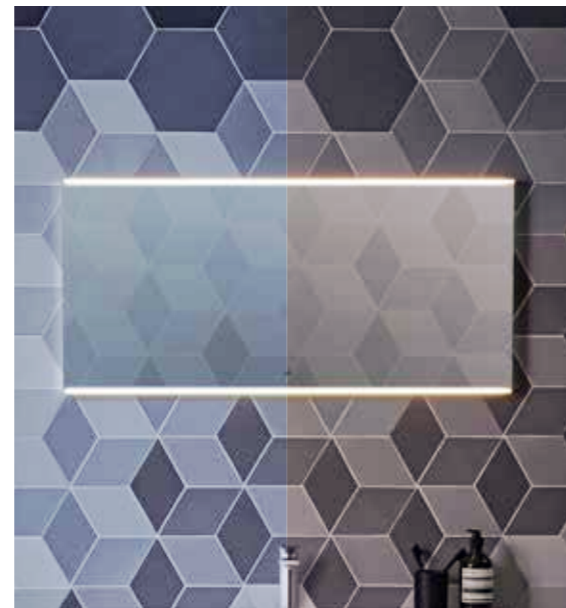

ADJUSTABLE LIGHTING
Cool to warm

Scheme Mirrors	Code	W x H x Dmm	RRP
500	MLE470C	500 x 710 x 47	£449.30
600	MLE530C	600 x 470 x 47	£408.50
800	MLE540C	800 x 470 x 47	£449.30
1000	MLE550C	1000 x 470 x 47	£529.90
1200	MLE560C	1200 x 470 x 47	£618.10



Soft rounded corners & slender profile
SYSTEM MIRRORS

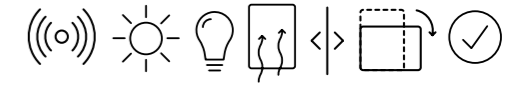

- Infrared switch controlled by contactless hand movements
- Adjustable LED colour temperature & brightness
- Heated demister pad prevents mirror steaming up
- Slim depth design
- IP44 rated



ADJUSTABLE LIGHTING
Cool to warm

System Mirrors	Code	W x H x Dmm	RRP
450	SYS45AL	450 x 700 x 25	£460.10
500/700	SYS70AL	500 x 700 x 25	£482.60
600/800	SYS80AL	600 x 800 x 25	£513.80
700/900	SYS90AL	700 x 900 x 25	£548.20
1200	SYS120AL	1200 x 600 x 25	£671.80

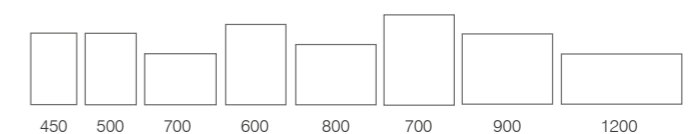

Timeless styling
TRADITIONAL MIRRORS

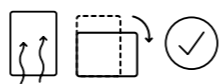

- Heated demister pad prevents mirror steaming up
- IP44 rated



Traditional Mirrors	Code	W x H x Dmm	RRP
430/700	WMB2022	430 x 700 x 30	£249.40
600/900	WMB2020	600 x 900 x 30	£308.50
1200	WMB2023	1200 x 600 x 30	£427.80



Ambient illumination
ORIGIN CABINETS



- Infrared switch controlled by contactless hand movements
- Adjustable LED colour temperature & brightness
- Illuminated side panels providing forward throw, ambient & internal illumination
- Built in charging socket for your shaver or toothbrush (x2 on double door cabinets)
- Additional USB charging socket
- Double sided soft close mirror doors with heated demister pad
- Adjustable aluminium shelves
- IP44 rated

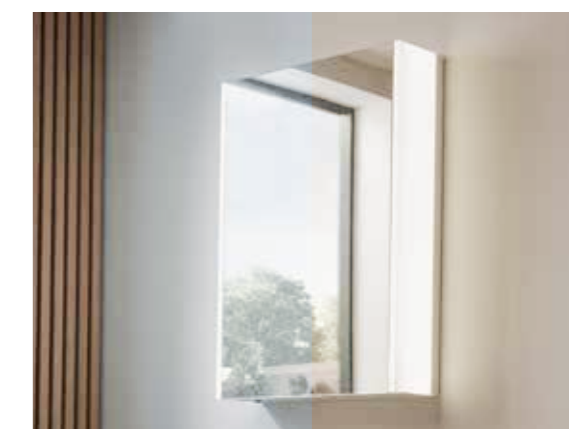

ADJUSTABLE LIGHTING
Cool to warm

Origin Cabinets	Code	W x H x Dmm	RRP
500 1 Door	RGC050	500 x 700 x 140	£795.50
600 2 Door	RGC060	600 x 700 x 140	£908.30
800 2 Door	RGC080	800 x 700 x 140	£1,053.50

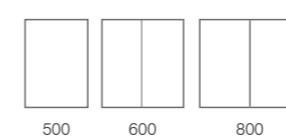

Versatility at its best
NOTION CABINETS



- Compatible with Loop vanity mirror
- Infrared switch controlled by contactless hand movements
- Adjustable LED colour temperature & brightness
- Internal lighting
- Mirrored sides
- Built in two-pin charging socket for your shaver or toothbrush
- Additional USB & USB-C charging socket
- Double sided push to open mirror doors with heated demister pad
- Adjustable smoked glass shelves
- IP44 rated



VANITY MIRROR UPGRADE
The Loop vanity mirror can be used with all Notion cabinets, see page 94 for details on the vanity mirror.

Notion Cabinets	Code	W x H x Dmm	RRP
500 1 Door	NTC050	490 x 700 x 120	£709.50
600 2 Door	NTC060	590 x 700 x 120	£822.30
800 2 Door	NTC080	790 x 700 x 120	£940.60

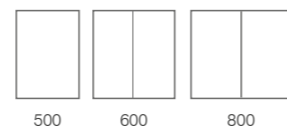

Modern space saving
BOOST CABINETS



- Wireless charging pad
- Infrared switch controlled by contactless hand movements
- Adjustable LED colour temperature & brightness
- Removable mirrored sides allowing surface mounting or recessing of cabinet
- Built in two-pin charging socket for your shaver or toothbrush
- USB & USB-C charging sockets
- Double sided push to open mirror doors with heated demister pad
- Adjustable smoked glass shelves with low profile supports
- Open storage area with adjustable aluminium shelves
- Supplied in a stylish matt black finish
- IP44 rated



5W WIRELESS CHARGING PAD
give your mobile a battery boost

Boost Cabinets	Code	W x H x Dmm	RRP
500 1 Door	BTC050	490 x 800 x 120	£795.50
600 2 Door	BTC060	590 x 800 x 120	£940.60
800 2 Door	BTC080	790 x 800 x 120	£1,053.50

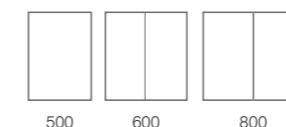

Soft curved edges

THEORY CABINETS



- Striking black framed door & sides
- Double sided soft close mirror doors
- Slim depth design
- Adjustable smoked glass shelves with low profile supports



Theory Cabinets	Code	W x H x Dmm	RRP
450 1 Door	TYC045	450 x 700 x 120	£368.70
600 2 Door	TYC060	600 x 700 x 120	£425.70

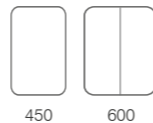

Bathroom illumination

PRESENCE CABINETS



- Touch control operation
- Adjustable LED colour temperature & brightness
- Built in charging socket for your shaver or toothbrush (x2 on double door cabinets)
- Additional USB charging socket
- Double sided soft close mirror doors with heated demister pad
- 2 adjustable glass shelves
- IP44 rated



ADJUSTABLE LIGHTING
Cool to warm

Presence Cabinets	Code	W x H x Dmm	RRP
500 1 Door	PSC050	500 x 700 x 130	£677.20
650 2 Door	PSC065	650 x 700 x 130	£854.60
800 2 Door	PSC080	800 x 700 x 130	£908.30
1000 2 Door	PSC100	1000 x 700 x 130	£1,015.80

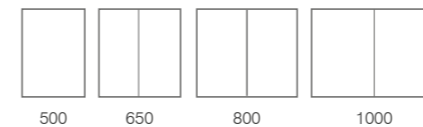

Recessed design
PURPOSE CABINETS



- Recessed cabinet
- Touch control operation
- Adjustable LED warmth, brightness and temperature control
- Built in charging socket for your shaver or toothbrush (x2 on double door cabinets)
- Additional USB charging socket
- Double sided soft close mirror doors with heated demister pad
- 2 adjustable glass shelves
- IP44 rated



ADJUSTABLE LIGHTING
Cool to warm

Purpose Cabinets	Code	W x H x Dmm (when recessed)	RRP
450 1 Door	PUC050	500 x 700 x 20	£677.20
650 2 Door	PUC065	650 x 700 x 20	£854.60
800 2 Door	PUC080	800 x 700 x 20	£908.30
1000 2 Door	PUC100	1000 x 700 x 20	£1,015.80



Soft rounded corners
SYSTEM CABINETS



- Infrared switch controlled by contactless hand movements
- Adjustable LED colour temperature & brightness
- Built in two-pin charging socket for your shaver or toothbrush
- Additional USB charging socket
- Double sided soft close mirror doors with heated demister pad
- 2 adjustable glass shelves
- IP44 rated

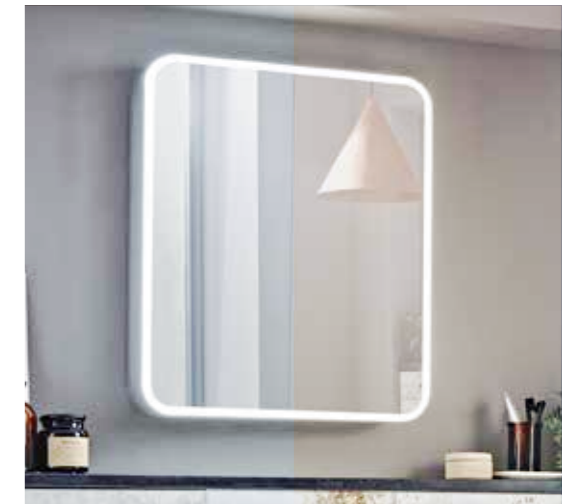

ADJUSTABLE LIGHTING
Cool to warm

System Cabinets	Code	W x H x Dmm	RRP
500 1 Door	SYC050	500 x 700 x 140	£688.00
600 2 Door	SYC060	600 x 700 x 140	£854.60
1000 2 Door	SYC100	1000 x 700 x 140	£1,015.80

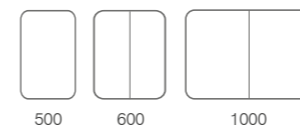

Bathroom lighting

LED BATHROOM LIGHTING



- For use on top of cabinets or mirrors
- 6 watt LED light
- Light is IP44 rated.
- Supplied with driver suitable for mounting outside bathroom zones 1 & 2 - behind mirror or cabinet

Choose an overhead light, designed for use on top of cabinets or mirrors. Benefit from the latest LED technology which provides a bright, practical task light with energy saving benefits. The light is IP44 rated and supplied with an LED driver suitable for mounting outside zones 1 and 2. See diagram on page 113.

The bathroom cabinets within our range of furniture feature a void behind the back panel, allowing wiring and transformers to be neatly concealed.

When planning your bathroom remember to make allowance for any electrical work which may have to be undertaken before any of your furniture is fitted. Always use a qualified electrician.

300 Chrome LED Light	Code	RRP
LED Light	LED300WL	£81.20



- Specifically designed for use in the bathroom
- IP44 rated

Lighting	Code	W x H x Dmm	RRP
1. LED Wall Light	LIGHT01	60 x 550 x 80	£209.00 each
2. LED Wall Light	WMB2030	60 x 410 x 90	£189.70 each

Bathroom charging

CHARGING STATION

Add further functionality to your new Roper Rhodes fitted furniture by adding our charging station. The subtle little unit can be installed into our floor cupboards or wall cabinets and includes both a two-pin charging socket and a USB port to keep all your electricals fully charged.

- Designed for use within fitted furniture cupboards and wall cabinets
- Includes a two-pin charging point with rocker switch
- Includes a USB charging socket
- Supplied in a modern matt black finish
- Designed with cover to hide sockets when not in use
- Screwless mounting
- Requires a mains connection (supplied with one metre flying lead)
- Not recommended for installations in semi-countertop units or drawers
- IP44



Charging station	Code	RRP
	DC6001	£147.80



ADD
A CHARGING STATION TO YOUR FURNITURE RUN

Bathroom zones

SAFETY ZONES & ELECTRICAL INFORMATION

ZONES FOR EQUIPMENT IN CLOSE PROXIMITY TO BATHS & SHOWERS

✓ Roper Rhodes illuminated mirror and aluminum cabinets have been independently tested for compliance with electrical equipment safety regulations. Products shown with the 'tick' icon are IP44 or IP55 rated and are suitable for use in zone 2 and outside zones in the bathroom



- ZONE 1** Electrical fittings in this zone require a separated extra low voltage and a minimum rating of IP44 (splash-proof)
- ZONE 2** Electrical fittings in this zone require a minimum rating of IP44 (splash-proof)
- OUTSIDE ZONES** Electrical fittings in this zone require a minimum rating of IP20

500MM BACK TO WALL WC UNITS



500MM STANDARD / SLIM DEPTH BACK TO WALL WC WITH FASCIA DOOR PACK

FEATURES

- Fascia to be cut on site to suit sanitaryware.
- Main panel goes to floor.
- Front access top fascia.
- For compatible back to wall WCs see pages 143-145.

* These fascia packs are designed to be used with comfort height WC pans & cisterns, so exclude the Burford moulding.

Unit Finish	Recommended Carcass		Fascia / Door Pack
	Standard Depth	Slim depth	

BURFORD STANDARD WC			
Juniper Green	F3BW5.D - Graphite	F2BW5.D - Graphite	DBW5.JNP
Coniston Blue	F3BW5.D - Graphite	F2BW5.D - Graphite	DBW5.CB
Derwent Blue	F3BW5.D - Graphite	F2BW5.D - Graphite	DBW5.DB
Mercury	F3BW5.D - Graphite	F2BW5.D - Graphite	DBW5.MY
Chalk White	F3BW5.OK - Natural Oak	F2BW5.OK - Natural Oak	DBW5.CW
Mocha	F3BW5.OK - Natural Oak	F2BW5.OK - Natural Oak	DBW5.MC
Pebble Grey	F3BW5.OK - Natural Oak	F2BW5.OK - Natural Oak	DBW5.PG
Slate Grey	F3BW5.OK - Natural Oak	F2BW5.OK - Natural Oak	DBW5.SG

BURFORD COMFORT HEIGHT WC			
Juniper Green	F3BW5.D - Graphite	F2BW5.D - Graphite	ABW5.JNP *
Coniston Blue	F3BW5.D - Graphite	F2BW5.D - Graphite	ABW5.CB *
Derwent Blue	F3BW5.D - Graphite	F2BW5.D - Graphite	ABW5.DB *
Mercury	F3BW5.D - Graphite	F2BW5.D - Graphite	ABW5.MY *
Chalk White	F3BW5.OK - Natural Oak	F2BW5.OK - Natural Oak	ABW5.CW *
Mocha	F3BW5.OK - Natural Oak	F2BW5.OK - Natural Oak	ABW5.MC *
Pebble Grey	F3BW5.OK - Natural Oak	F2BW5.OK - Natural Oak	ABW5.PG *
Slate Grey	F3BW5.OK - Natural Oak	F2BW5.OK - Natural Oak	ABW5.SG *

ARUBA			
Juniper Green	F3BW5.D - Graphite	F2BW5.D - Graphite	ABW5.JNP
Powder Grey	F3BW5.D - Graphite	F2BW5.D - Graphite	ABW5.POW
Mussel	F3BW5.D - Graphite	F2BW5.D - Graphite	ABW5.MSL
Derwent Blue	F3BW5.D - Graphite	F2BW5.D - Graphite	ABW5.DB
Alpine Elm	F3BW5.D - Graphite	F2BW5.D - Graphite	ABW5.AE
Gloss Dark Clay	F3BW5.D - Graphite	F2BW5.D - Graphite	ABW5.GDC
Mocha	F3BW5.D - Graphite	F2BW5.D - Graphite	ABW5.MC
Flintwood	F3BW5.D - Graphite	F2BW5.D - Graphite	ABW5.FW
White	F3BW5.W - White	F2BW5.W - White	ABW5.W

VETRO			
Light Grey	F3BW5.D - Graphite	F2BW5.D - Graphite	VBW5.VG
White	F3BW5.D - Graphite	F2BW5.D - Graphite	VBW5.VW

£346.10 each

£321.40 each

£187.00 each



Exposed carcass sides are covered by using colour matched end panels which will be required to complete your fitted furniture run. See pages 138-141 for panel options.



Most freestanding units require a colour matched plinth to be installed to cover any pipework underneath the units. See pages 138-141 for plinth options.

600MM BACK TO WALL WC UNITS



600MM STANDARD / SLIM DEPTH BACK TO WALL WC WITH FASCIA DOOR PACK

FEATURES

- Fascia to be cut on site to suit sanitaryware.
- Main panel goes to floor.
- Front access top fascia.
- For compatible back to wall WCs see pages 143-145.

* These fascia packs are designed to be used with comfort height WC pans & cisterns, so exclude the Burford moulding.

Unit Finish	Recommended Carcass		Fascia / Door Pack
	Standard Depth	Slim depth	

BURFORD STANDARD WC			
Juniper Green	F3BW6.D - Graphite	F2BW6.D - Graphite	DBW6.JNP
Coniston Blue	F3BW6.D - Graphite	F2BW6.D - Graphite	DBW6.CB
Derwent Blue	F3BW6.D - Graphite	F2BW6.D - Graphite	DBW6.DB
Mercury	F3BW6.D - Graphite	F2BW6.D - Graphite	DBW6.MY
Chalk White	F3BW6.OK - Natural Oak	F2BW6.OK - Natural Oak	DBW6.CW
Mocha	F3BW6.OK - Natural Oak	F2BW6.OK - Natural Oak	DBW6.MC
Pebble Grey	F3BW6.OK - Natural Oak	F2BW6.OK - Natural Oak	DBW6.PG
Slate Grey	F3BW6.OK - Natural Oak	F2BW6.OK - Natural Oak	DBW6.SG

BURFORD COMFORT HEIGHT WC			
Juniper Green	F3BW6.D - Graphite	F2BW6.D - Graphite	ABW6.JNP *
Coniston Blue	F3BW6.D - Graphite	F2BW6.D - Graphite	ABW6.CB *
Derwent Blue	F3BW6.D - Graphite	F2BW6.D - Graphite	ABW6.DB *
Mercury	F3BW6.D - Graphite	F2BW6.D - Graphite	ABW6.MY *
Chalk White	F3BW6.OK - Natural Oak	F2BW6.OK - Natural Oak	ABW6.CW *
Mocha	F3BW6.OK - Natural Oak	F2BW6.OK - Natural Oak	ABW6.MC *
Pebble Grey	F3BW6.OK - Natural Oak	F2BW6.OK - Natural Oak	ABW6.PG *
Slate Grey	F3BW6.OK - Natural Oak	F2BW6.OK - Natural Oak	ABW6.SG *

ARUBA			
Juniper Green	F3BW6.D - Graphite	F2BW6.D - Graphite	ABW6.JNP
Powder Grey	F3BW6.D - Graphite	F2BW6.D - Graphite	ABW6.POW
Mussel	F3BW6.D - Graphite	F2BW6.D - Graphite	ABW6.MSL
Derwent Blue	F3BW6.D - Graphite	F2BW6.D - Graphite	ABW6.CB
Alpine Elm	F3BW6.D - Graphite	F2BW6.D - Graphite	ABW6.AE
Gloss Dark Clay	F3BW6.D - Graphite	F2BW6.D - Graphite	ABW6.GDC
Mocha	F3BW6.D - Graphite	F2BW6.D - Graphite	ABW6.MC
Flintwood	F3BW6.D - Graphite	F2BW6.D - Graphite	ABW6.FW
White	F3BW6.W - White	F2BW6.W - White	ABW6.W

VETRO			
Light Grey	F3BW6.D - Graphite	F2BW6.D - Graphite	VBW6.VG
White	F3BW6.D - Graphite	F2BW6.D - Graphite	VBW6.VW

£368.70 each

£346.10 each

£209.00 each



Exposed carcass sides are covered by using colour matched end panels which will be required to complete your fitted furniture run. See pages 138-141 for panel options.



Most freestanding units require a colour matched plinth to be installed to cover any pipework underneath the units. See pages 138-141 for plinth options.

500MM BASIN UNITS

DON'T FORGET TO ORDER YOUR HANDLES SEE PAGES 132-133

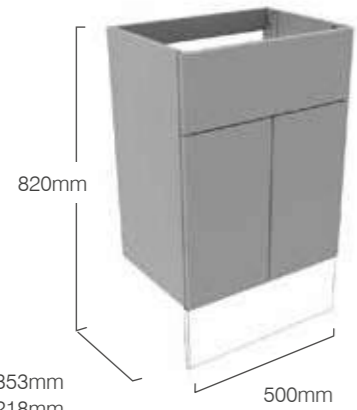

Standard depth 353mm
Slim depth 218mm

500MM STANDARD / SLIM DEPTH BASIN UNIT WITH FASCIA DOOR PACK

FEATURES

- Fascia to be cut on site to suit sanitaryware.
- One adjustable shelf.
- Soft close hinges.
- Removable back panel.
- For compatible basins see pages 151-153.
- A plinth is required for this unit - see pages 138-141.

Unit Finish	Recommended Carcass		Fascia / Door Pack
	Standard Depth	Slim depth	
BURFORD			
Juniper Green	F3SC5.D - Graphite	F2SC5.D - Graphite	DSC5.JNP
Coniston Blue	F3SC5.D - Graphite	F2SC5.D - Graphite	DSC5.CB
Derwent Blue	F3SC5.D - Graphite	F2SC5.D - Graphite	DSC5.DB
Mercury	F3SC5.D - Graphite	F2SC5.D - Graphite	DSC5.MY
Chalk White	F3SC5.OK - Natural Oak	F2SC5.OK - Natural Oak	DSC5.CW
Mocha	F3SC5.OK - Natural Oak	F2SC5.OK - Natural Oak	DSC5.MC
Pebble Grey	F3SC5.OK - Natural Oak	F2SC5.OK - Natural Oak	DSC5.PG
Slate Grey	F3SC5.OK - Natural Oak	F2SC5.OK - Natural Oak	DSC5.SG
ARUBA			
Juniper Green	F3SC5.D - Graphite	F2SC5.D - Graphite	ASC5.JNP
Powder Grey	F3SC5.D - Graphite	F2SC5.D - Graphite	ASC5.POW
Mussel	F3SC5.D - Graphite	F2SC5.D - Graphite	ASC5.MSL
Derwent Blue	F3SC5.D - Graphite	F2SC5.D - Graphite	ASC5.DB
Alpine Elm	F3SC5.D - Graphite	F2SC5.D - Graphite	ASC5.AE
Gloss Dark Clay	F3SC5.D - Graphite	F2SC5.D - Graphite	ASC5.GDC
Mocha	F3SC5.D - Graphite	F2SC5.D - Graphite	ASC5.MC
Flintwood	F3SC5.D - Graphite	F2SC5.D - Graphite	ASC5.FW
White	F3SC5.W - White	F2SC5.W - White	ASC5.W
VETRO			
Light Grey	F3SC5.D - Graphite	F2SC5.D - Graphite	VSC5.VG
White	F3SC5.D - Graphite	F2SC5.D - Graphite	VSC5.VW
	£322.50 each	£314.90 each	£189.70 each

END PANELS REQUIRED

Exposed carcass sides are covered by using colour matched end panels which will be required to complete your fitted furniture run. See pages 138-141 for panel options.

PLINTH REQUIRED

Most freestanding units require a colour matched plinth to be installed to cover any pipework underneath the units. See pages 138-141 for plinth options.

600MM BASIN UNITS

DON'T FORGET TO ORDER YOUR HANDLES SEE PAGES 132-133

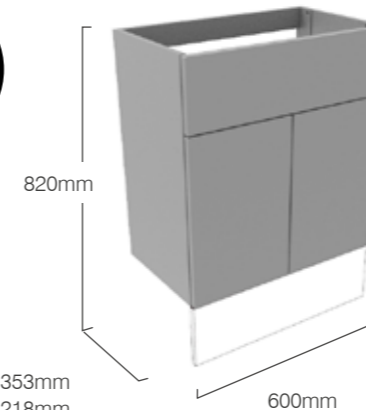

Standard depth 353mm
Slim depth 218mm

600MM STANDARD / SLIM DEPTH BASIN UNIT WITH FASCIA DOOR PACK

FEATURES

- Fascia to be cut on site to suit sanitaryware.
- One adjustable shelf.
- Soft close hinges.
- Removable back panel.
- For compatible basins see pages 151-153.
- A plinth is required for this unit - see pages 138-141.

Unit Finish	Recommended Carcass		Fascia / Door Pack
	Standard Depth	Slim depth	
BURFORD			
Juniper Green	F3SC6.D - Graphite	F2SC6.D - Graphite	DSC6.JNP
Coniston Blue	F3SC6.D - Graphite	F2SC6.D - Graphite	DSC6.CB
Derwent Blue	F3SC6.D - Graphite	F2SC6.D - Graphite	DSC6.DB
Mercury	F3SC6.D - Graphite	F2SC6.D - Graphite	DSC6.MY
Chalk White	F3SC6.OK - Natural Oak	F2SC6.OK - Natural Oak	DSC6.CW
Mocha	F3SC6.OK - Natural Oak	F2SC6.OK - Natural Oak	DSC6.MC
Pebble Grey	F3SC6.OK - Natural Oak	F2SC6.OK - Natural Oak	DSC6.PG
Slate Grey	F3SC6.OK - Natural Oak	F2SC6.OK - Natural Oak	DSC6.SG
ARUBA			
Juniper Green	F3SC6.D - Graphite	F2SC6.D - Graphite	ASC6.JNP
Powder Grey	F3SC6.D - Graphite	F2SC6.D - Graphite	ASC6.POW
Mussel	F3SC6.D - Graphite	F2SC6.D - Graphite	ASC6.MSL
Derwent Blue	F3SC6.D - Graphite	F2SC6.D - Graphite	ASC6.DB
Alpine Elm	F3SC6.D - Graphite	F2SC6.D - Graphite	ASC6.AE
Gloss Dark Clay	F3SC6.D - Graphite	F2SC6.D - Graphite	ASC6.GDC
Mocha	F3SC6.D - Graphite	F2SC6.D - Graphite	ASC6.MC
Flintwood	F3SC6.D - Graphite	F2SC6.D - Graphite	ASC6.FW
White	F3SC6.W - White	F2SC6.W - White	ASC6.W
VETRO			
Light Grey	F3SC6.D - Graphite	F2SC6.D - Graphite	VSC6.VG
White	F3SC6.D - Graphite	F2SC6.D - Graphite	VSC6.VW
	£370.80 each	£348.30 each	£209.00 each

END PANELS REQUIRED

Exposed carcass sides are covered by using colour matched end panels which will be required to complete your fitted furniture run. See pages 138-141 for panel options.

PLINTH REQUIRED

Most freestanding units require a colour matched plinth to be installed to cover any pipework underneath the units. See pages 138-141 for plinth options.

600MM UNDERSLUNG BASIN UNITS

DON'T FORGET TO ORDER YOUR HANDLES SEE PAGES 132-133

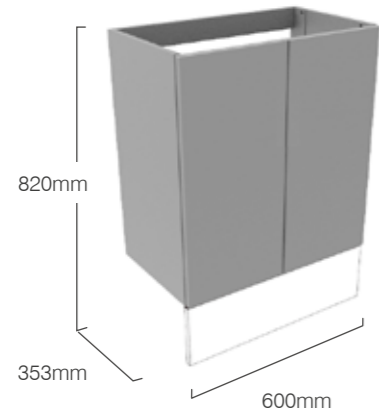

600MM STANDARD UNDERSLUNG UNIT WITH FASCIA DOOR PACK

FEATURES

- One adjustable shelf.
- Soft close hinges.
- Removable back panel.
- Compatible with compact grade laminate worktops & underslung basin – see page 136.
- A plinth is required for this unit - see pages 138-141.

Unit Finish	Recommended Carcass		Fascia / Door Pack
	Standard Depth	Slim depth	
BURFORD			
Juniper Green	F3US6.D - Graphite	-	DFC3.JNP x2
Coniston Blue	F3US6.D - Graphite	-	DFC3.CB x2
Derwent Blue	F3US6.D - Graphite	-	DFC3.DB x2
Mercury	F3US6.D - Graphite	-	DFC3.MY x2
Chalk White	F3US6.OK - Natural Oak	-	DFC3.CW x2
Mocha	F3US6.OK - Natural Oak	-	DFC3.MC x2
Pebble Grey	F3US6.OK - Natural Oak	-	DFC3.PG x2
Slate Grey	F3US6.OK - Natural Oak	-	DFC3.SG x2
ARUBA			
Juniper Green	F3US6.D - Graphite	-	AFC3.JNP x2
Powder Grey	F3US6.D - Graphite	-	AFC3.POW x2
Mussel	F3US6.D - Graphite	-	AFC3.MSL x2
Derwent Blue	F3US6.D - Graphite	-	AFC3.DB x2
Alpine Elm	F3US6.D - Graphite	-	AFC3.AE x2
Gloss Dark Clay	F3US6.D - Graphite	-	AFC3.GDC x2
Mocha	F3US6.D - Graphite	-	AFC3.MC x2
Flintwood	F3US6.D - Graphite	-	AFC3.FW x2
White	F3US6.W - White	-	AFC3.W x2
VETRO			
Light Grey	F3US6.D - Graphite	-	VFC3.VG x2
White	F3US6.D - Graphite	-	VFC3.VW x2

£370.80 each

£80.80 each

END PANELS REQUIRED

Exposed carcass sides are covered by using colour matched end panels which will be required to complete your fitted furniture run. See pages 138-141 or panel options.

PLINTH REQUIRED

Most freestanding units require a colour matched plinth to be installed to cover any pipework underneath the units. See pages 138-141 for plinth options.

700MM BASIN UNITS

DON'T FORGET TO ORDER YOUR HANDLES SEE PAGES 132-133

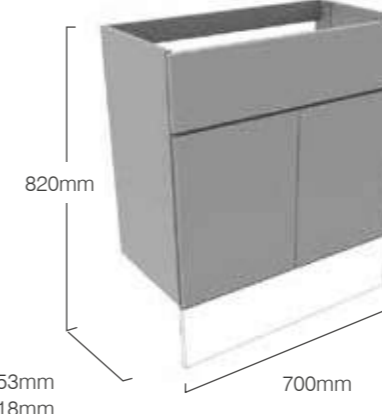

700MM STANDARD / SLIM DEPTH BASIN UNIT WITH FASCIA DOOR PACK

FEATURES

- Fascia to be cut on site to suit sanitaryware.
- One adjustable shelf.
- Soft close hinges.
- Removable back panel.
- For compatible basins see pages 151-153.
- A plinth is required for this unit - see pages 138-141.

Unit Finish	Recommended Carcass		Fascia / Door Pack
	Standard Depth	Slim depth	
BURFORD			
Juniper Green	F3SC7.D - Graphite	F2SC7.D - Graphite	DSC7.JNP
Coniston Blue	F3SC7.D - Graphite	F2SC7.D - Graphite	DSC7.CB
Derwent Blue	F3SC7.D - Graphite	F2SC7.D - Graphite	DSC7.DB
Mercury	F3SC7.D - Graphite	F2SC7.D - Graphite	DSC7.MY
Chalk White	F3SC7.OK - Natural Oak	F2SC7.OK - Natural Oak	DSC7.CW
Mocha	F3SC7.OK - Natural Oak	F2SC7.OK - Natural Oak	DSC7.MC
Pebble Grey	F3SC7.OK - Natural Oak	F2SC7.OK - Natural Oak	DSC7.PG
Slate Grey	F3SC7.OK - Natural Oak	F2SC7.OK - Natural Oak	DSC7.SG
ARUBA			
Juniper Green	F3SC7.D - Graphite	F2SC7.D - Graphite	ASC7.JNP
Powder Grey	F3SC7.D - Graphite	F2SC7.D - Graphite	ASC7.POW
Mussel	F3SC7.D - Graphite	F2SC7.D - Graphite	ASC7.MSL
Derwent Blue	F3SC7.D - Graphite	F2SC7.D - Graphite	ASC7.DB
Alpine Elm	F3SC7.D - Graphite	F2SC7.D - Graphite	ASC7.AE
Gloss Dark Clay	F3SC7.D - Graphite	F2SC7.D - Graphite	ASC7.GDC
Mocha	F3SC7.D - Graphite	F3SC7.D - Graphite	ASC7.MC
Flintwood	F3SC7.D - Graphite	F2SC7.D - Graphite	ASC7.FW
White	F3SC7.W - White	F2SC7.W - White	ASC7.W
VETRO			
Light Grey	F3SC7.D - Graphite	F2SC7.D - Graphite	VSC7.VG
White	F3SC7.D - Graphite	F2SC7.D - Graphite	VSC7.VW

£381.60 each

£360.10 each

£231.60 each

END PANELS REQUIRED

Exposed carcass sides are covered by using colour matched end panels which will be required to complete your fitted furniture run. See pages 138-141 for panel options.

PLINTH REQUIRED

Most freestanding units require a colour matched plinth to be installed to cover any pipework underneath the units. See pages 138-141 for plinth options.

200MM FLOOR CUPBOARDS

DON'T FORGET TO ORDER YOUR HANDLES SEE PAGES 132-133

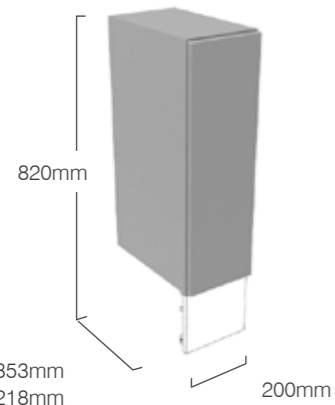

Standard depth 353mm
Slim depth 218mm

200MM STANDARD / SLIM DEPTH FLOOR CUPBOARD WITH FASCIA DOOR PACK

FEATURES

- Soft close hinges.
- One adjustable shelf.
- Reversible door.
- A plinth is required for this unit - see pages 138-141.

* These products have plain fronted fascia packs.

Unit Finish	Recommended Carcass		Fascia / Door Pack
	Standard Depth	Slim depth	
BURFORD			
Juniper Green *	F3FC2.D - Graphite	F2FC2.D - Graphite	FC2.JNP
Coniston Blue *	F3FC2.D - Graphite	F2FC2.D - Graphite	FC2.CB
Derwent Blue *	F3FC2.D - Graphite	F2FC2.D - Graphite	FC2.DB
Mercury *	F3FC2.D - Graphite	F2FC2.D - Graphite	FC2.MY
Chalk White *	F3FC2.OK - Natural Oak	F2FC2.OK - Natural Oak	FC2.CW
Mocha *	F3FC2.OK - Natural Oak	F2FC2.OK - Natural Oak	FC2.MC
Pebble Grey *	F3FC2.OK - Natural Oak	F2FC2.OK - Natural Oak	FC2.PG
Slate Grey *	F3FC2.OK - Natural Oak	F2FC2.OK - Natural Oak	FC2.SG
ARUBA			
Juniper Green	F3FC2.D - Graphite	F2FC2.D - Graphite	FC2.JNP
Powder Grey	F3FC2.D - Graphite	F2FC2.D - Graphite	FC2.POW
Mussel	F3FC2.D - Graphite	F2FC2.D - Graphite	FC2.MSL
Derwent Blue	F3FC2.D - Graphite	F2FC2.D - Graphite	FC2.DB
Alpine Elm	F3FC2.D - Graphite	F2FC2.D - Graphite	FC2.AE
Gloss Dark Clay	F3FC2.D - Graphite	F2FC2.D - Graphite	FC2.GDC
Mocha	F3FC2.D - Graphite	F2FC2.D - Graphite	FC2.MC
Flintwood	F3FC2.D - Graphite	F2FC2.D - Graphite	FC2.FW
White	F3FC2.W - White	F2FC2.W - White	FC2.W
VETRO			
Light Grey	F3FC2.D - Graphite	F2FC2.D - Graphite	VFC2.VG
White	F3FC2.D - Graphite	F2FC2.D - Graphite	VFC2.VW
	£252.60 each	£229.50 each	£69.30 each

END PANELS REQUIRED

Exposed carcass sides are covered by using colour matched end panels which will be required to complete your fitted furniture run. See pages 138-141 or panel options.

PLINTH REQUIRED

Most freestanding units require a colour matched plinth to be installed to cover any pipework underneath the units. See pages 138-141 for plinth options.

300MM FLOOR CUPBOARDS

DON'T FORGET TO ORDER YOUR HANDLES SEE PAGES 132-133

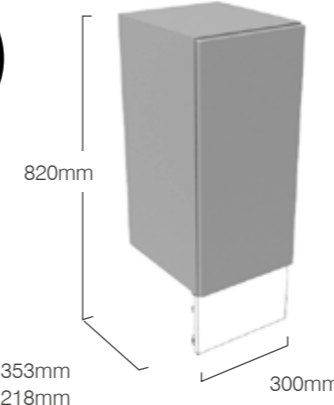

Standard depth 353mm
Slim depth 218mm

300MM STANDARD / SLIM DEPTH FLOOR CUPBOARD WITH FASCIA DOOR PACK

FEATURES

- Soft close hinges.
- One adjustable shelf.
- Reversible door.
- A plinth is required for this unit - see pages 138-141.

Unit Finish	Recommended Carcass		Fascia / Door Pack
	Standard Depth	Slim depth	
BURFORD			
Juniper Green	F3FC3.D - Graphite	F2FC3.D - Graphite	DFC3.JNP
Coniston Blue	F3FC3.D - Graphite	F2FC3.D - Graphite	DFC3.CB
Derwent Blue	F3FC3.D - Graphite	F2FC3.D - Graphite	DFC3.DB
Mercury	F3FC3.D - Graphite	F2FC3.D - Graphite	DFC3.MY
Chalk White	F3FC3.OK - Natural Oak	F2FC3.OK - Natural Oak	DFC3.CW
Mocha	F3FC3.OK - Natural Oak	F2FC3.OK - Natural Oak	DFC3.MC
Pebble Grey	F3FC3.OK - Natural Oak	F2FC3.OK - Natural Oak	DFC3.PG
Slate Grey	F3FC3.OK - Natural Oak	F2FC3.OK - Natural Oak	DFC3.SG
ARUBA			
Juniper Green	F3FC3.D - Graphite	F2FC3.D - Graphite	AFC3.JNP
Powder Grey	F3FC3.D - Graphite	F2FC3.D - Graphite	AFC3.POW
Mussel	F3FC3.D - Graphite	F2FC3.D - Graphite	AFC3.MSL
Derwent Blue	F3FC3.D - Graphite	F2FC3.D - Graphite	AFC3.DB
Alpine Elm	F3FC3.D - Graphite	F2FC3.D - Graphite	AFC3.AE
Gloss Dark Clay	F3FC3.D - Graphite	F2FC3.D - Graphite	AFC3.GDC
Mocha	F3FC3.D - Graphite	F2FC3.D - Graphite	AFC3.MC
Flintwood	F3FC3.D - Graphite	F2FC3.D - Graphite	AFC3.FW
White	F3FC3.W - White	F2FC3.W - White	AFC3.W
VETRO			
Light Grey	F3FC3.D - Graphite	F2FC3.D - Graphite	VFC3.VG
White	F3FC3.D - Graphite	F2FC3.D - Graphite	VFC3.VW
	£263.30 each	£241.80 each	£80.80 each

END PANELS REQUIRED

Exposed carcass sides are covered by using colour matched end panels which will be required to complete your fitted furniture run. See pages 138-141 for panel options.

PLINTH REQUIRED

Most freestanding units require a colour matched plinth to be installed to cover any pipework underneath the units. See pages 138-141 for plinth options.

400MM FLOOR CUPBOARDS

DON'T FORGET TO ORDER YOUR HANDLES SEE PAGES 132-133

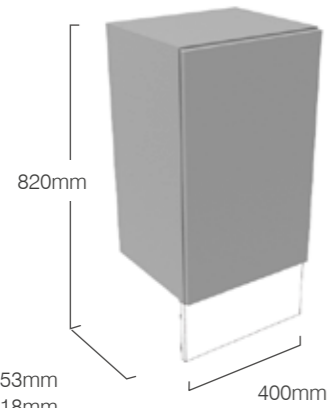

Standard depth 353mm
Slim depth 218mm

400MM STANDARD / SLIM DEPTH FLOOR CUPBOARD WITH FASCIA DOOR PACK

FEATURES

- Soft close hinges.
- One adjustable shelf.
- Reversible door.
- A plinth is required for this unit - see pages 138-141.

Unit Finish	Recommended Carcass		Fascia / Door Pack
	Standard Depth	Slim depth	
BURFORD			
Juniper Green	F3FC4.D - Graphite	F2FC4.D - Graphite	DFC4.JNP
Coniston Blue	F3FC4.D - Graphite	F2FC4.D - Graphite	DFC4.CB
Derwent Blue	F3FC4.D - Graphite	F2FC4.D - Graphite	DFC4.DB
Mercury	F3FC4.D - Graphite	F2FC4.D - Graphite	DFC4.MY
Chalk White	F3FC4.OK - Natural Oak	F2FC4.OK - Natural Oak	DFC4.CW
Mocha	F3FC4.OK - Natural Oak	F2FC4.OK - Natural Oak	DFC4.MC
Pebble Grey	F3FC4.OK - Natural Oak	F2FC4.OK - Natural Oak	DFC4.PG
Slate Grey	F3FC4.OK - Natural Oak	F2FC4.OK - Natural Oak	DFC4.SG
ARUBA			
Juniper Green	F3FC4.D - Graphite	F2FC4.D - Graphite	AFC4.JNP
Powder Grey	F3FC4.D - Graphite	F2FC4.D - Graphite	AFC4.POW
Mussel	F3FC4.D - Graphite	F2FC4.D - Graphite	AFC4.MSL
Derwent Blue	F3FC4.D - Graphite	F2FC4.D - Graphite	AFC4.DB
Alpine Elm	F3FC4.D - Graphite	F2FC4.D - Graphite	AFC4.AE
Gloss Dark Clay	F3FC4.D - Graphite	F2FC4.D - Graphite	AFC4.GDC
Mocha	F3FC4.D - Graphite	F2FC4.D - Graphite	AFC4.MC
Flintwood	F3FC4.D - Graphite	F2FC4.D - Graphite	AFC4.FW
White	F3FC4.W - White	F2FC4.W - White	AFC4.W
VETRO			
Light Grey	F3FC4.D - Graphite	F2FC4.D - Graphite	VFC4.VG
White	F3FC4.D - Graphite	F2FC4.D - Graphite	VFC4.VW
	£299.90 each	£253.10 each	£92.20 each

END PANELS REQUIRED

Exposed carcass sides are covered by using colour matched end panels which will be required to complete your fitted furniture run. See pages 138-141 for panel options.

PLINTH REQUIRED

Most freestanding units require a colour matched plinth to be installed to cover any pipework underneath the units. See pages 138-141 for plinth options.

600MM FLOOR CUPBOARDS

DON'T FORGET TO ORDER YOUR HANDLES SEE PAGES 132-133

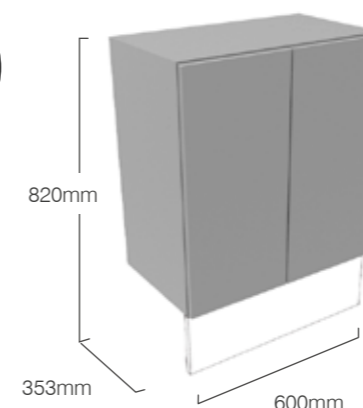

353mm 600mm

600MM STANDARD / SLIM DEPTH FLOOR CUPBOARD WITH FASCIA DOOR PACK

FEATURES

- Soft close hinges.
- One adjustable shelf.
- A plinth is required for this unit - see pages 138-141.

Unit Finish	Recommended Carcass		Fascia / Door Pack
	Standard Depth	Slim depth	
BURFORD			
Juniper Green	F3FC6.D - Graphite	-	DFC3.JNP X2
Coniston Blue	F3FC6.D - Graphite	-	DFC3.CB X2
Derwent Blue	F3FC6.D - Graphite	-	DFC3.DB X2
Mercury	F3FC6.D - Graphite	-	DFC3.MY X2
Chalk White	F3FC6.OK - Natural Oak	-	DFC3.CW X2
Mocha	F3FC6.OK - Natural Oak	-	DFC3.MC X2
Pebble Grey	F3FC6.OK - Natural Oak	-	DFC3.PG X2
Slate Grey	F3FC6.OK - Natural Oak	-	DFC3.SG X2
ARUBA			
Juniper Green	F3FC6.D - Graphite	-	AFC3.JNP X2
Powder Grey	F3FC6.D - Graphite	-	AFC3.POW X2
Mussel	F3FC6.D - Graphite	-	AFC3.MSL X2
Derwent Blue	F3FC6.D - Graphite	-	AFC3.DB X2
Alpine Elm	F3FC6.D - Graphite	-	AFC3.AE X2
Gloss Dark Clay	F3FC6.D - Graphite	-	AFC3.GDC X2
Mocha	F3FC6.D - Graphite	-	AFC3.MC X2
Flintwood	F3FC6.D - Graphite	-	AFC3.FW X2
White	F3FC6.W - White	-	AFC3.W X2
VETRO			
Light Grey	F3FC6.D - Graphite	-	VFC3.VG X2
White	F3FC6.D - Graphite	-	VFC3.VW X2
	£339.70 each		£80.80 each

END PANELS REQUIRED

Exposed carcass sides are covered by using colour matched end panels which will be required to complete your fitted furniture run. See pages 138-141 for panel options.

PLINTH REQUIRED

Most freestanding units require a colour matched plinth to be installed to cover any pipework underneath the units. See pages 138-141 for plinth options.

300MM SHELF STORAGE UNITS

300MM STANDARD / SLIM SHELF STORAGE UNIT

FEATURES

- Can be cut down to suit odd size space in furniture run.
- Supplied for self assembly.
- A plinth is required for this unit - see pages 138-141.

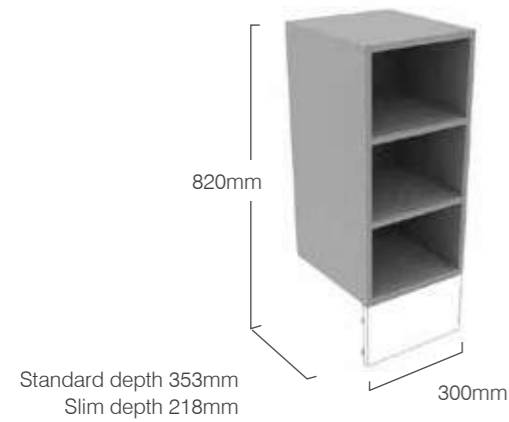

Unit Finish	Recommended Carcass		Fascia / Door Pack
	Standard Depth	Slim depth	
SHELF STORAGE UNIT			
-	F3SS3.D - Graphite	F2SS3.D - Graphite	-
-	F3SS3.OK - Natural Oak	F2SS3.OK - Natural Oak	-
-	F3SS3.W - White	F2SS3.W - White	-
	£197.80 each	£174.60 each	



Exposed carcass sides are covered by using colour matched end panels which will be required to complete your fitted furniture run. See pages 138-141 for panel options.



Most freestanding units require a colour matched plinth to be installed to cover any pipework underneath the units. See pages 138-141 for plinth options.

300MM TRIPLE DRAWER UNITS

300MM STANDARD DEPTH TRIPLE DRAWER UNIT WITH FASCIA DOOR PACK

FEATURES

- Soft close drawers.
- Fascias easily aligned.
- A plinth is required for this unit - see pages 138-141.

* These products have plain fronted fascia packs.

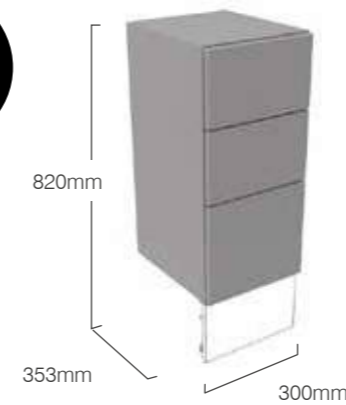

Unit Finish	Recommended Carcass		Fascia / Door Pack
	Standard Depth	Slim depth	
BURFORD			
Juniper Green *	F33DR.D - Graphite	-	3DR.JNP
Coniston Blue *	F33DR.D - Graphite	-	3DR.CB
Derwent Blue *	F33DR.D - Graphite	-	3DR.DB
Mercury *	F33DR.D - Graphite	-	3DR.MY
Chalk White *	F33DR.OK - Natural Oak	-	3DR.CW
Mocha *	F33DR.OK - Natural Oak	-	3DR.MC
Pebble Grey *	F33DR.OK - Natural Oak	-	3DR.PG
Slate Grey *	F33DR.OK - Natural Oak	-	3DR.SG
ARUBA			
Juniper Green	F33DR.D - Graphite	-	3DR.JNP
Powder Grey	F33DR.D - Graphite	-	3DR.POW
Mussel	F33DR.D - Graphite	-	3DR.MSL
Derwent Blue	F33DR.D - Graphite	-	3DR.DB
Alpine Elm	F33DR.D - Graphite	-	3DR.AE
Gloss Dark Clay	F33DR.D - Graphite	-	3DR.GDC
Mocha	F33DR.D - Graphite	-	3DR.MC
Flintwood	F33DR.D - Graphite	-	3DR.FW
White	F33DR.W - White	-	3DR.W
VETRO			
Light Grey	F33DR.D - Graphite	-	V3DR.VG
White	F33DR.D - Graphite	-	V3DR.VW
	£698.70 each		£93.30 each

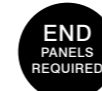

Exposed carcass sides are covered by using colour matched end panels which will be required to complete your fitted furniture run. See pages 138-141 for panel options.



Most freestanding units require a colour matched plinth to be installed to cover any pipework underneath the units. See pages 138-141 for plinth options.

200MM TOILET ROLL HOLDER CUPBOARDS

DON'T FORGET TO ORDER YOUR HANDLES SEE PAGES 132-133

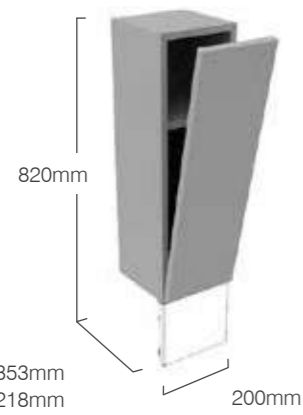

200MM STANDARD / SLIM DEPTH TOILET ROLL HOLDER CUPBOARD WITH FASCIA DOOR PACK

FEATURES

- Pull down door (plain door on Burford).
- Toilet roll stored on back of door.
- A plinth is required for this unit - see pages 138-141.

* These products have plain fronted fascia packs.

Standard depth 353mm
Slim depth 218mm

Unit Finish	Recommended Carcass		Fascia / Door Pack
	Standard Depth	Slim depth	
BURFORD			
Juniper Green *	F3TR2.D - Graphite	F2TR2.D - Graphite	TR2.JNP
Coniston Blue *	F3TR2.D - Graphite	F2TR2.D - Graphite	TR2.CB
Derwent Blue *	F3TR2.D - Graphite	F2TR2.D - Graphite	TR2.DB
Mercury *	F3TR2.D - Graphite	F2TR2.D - Graphite	TR2.MY
Chalk White *	F3TR2.OK - Natural Oak	F2TR2.OK - Natural Oak	TR2.CW
Mocha *	F3TR2.OK - Natural Oak	F2TR2.OK - Natural Oak	TR2.MC
Pebble Grey *	F3TR2.OK - Natural Oak	F2TR2.OK - Natural Oak	TR2.PG
Slate Grey *	F3TR2.OK - Natural Oak	F2TR2.OK - Natural Oak	TR2.SG
ARUBA			
Juniper Green	F3TR2.D - Graphite	F2TR2.D - Graphite	TR2.JNP
Powder Grey	F3TR2.D - Graphite	F2TR2.D - Graphite	TR2.POW
Mussel	F3TR2.D - Graphite	F2TR2.D - Graphite	TR2.MSL
Derwent Blue	F3TR2.D - Graphite	F2TR2.D - Graphite	TR2.DB
Alpine Elm	F3TR2.D - Graphite	F2TR2.D - Graphite	TR2.AE
Gloss Dark Clay	F3TR2.D - Graphite	F2TR2.D - Graphite	TR2.GDC
Mocha	F3TR2.D - Graphite	F2TR2.D - Graphite	TR2.MC
Flintwood	F3TR2.D - Graphite	F2TR2.D - Graphite	TR2.FW
White	F3TR2.W - White	F2TR2.W - White	TR2.W
VETRO			
Light Grey	F3TR2.D - Graphite	F2TR2.D - Graphite	VTR2.VG
White	F3TR2.D - Graphite	F2TR2.D - Graphite	VTR2.VW
	£381.60 each	£360.10 each	£69.30 each

END PANELS REQUIRED

Exposed carcass sides are covered by using colour matched end panels which will be required to complete your fitted furniture run. See pages 138-141 for panel options.

PLINTH REQUIRED

Most freestanding units require a colour matched plinth to be installed to cover any pipework underneath the units. See pages 138-141 for plinth options.

300MM FULL HEIGHT TWIN DOOR CUPBOARD

DON'T FORGET TO ORDER YOUR HANDLES SEE PAGES 132-133

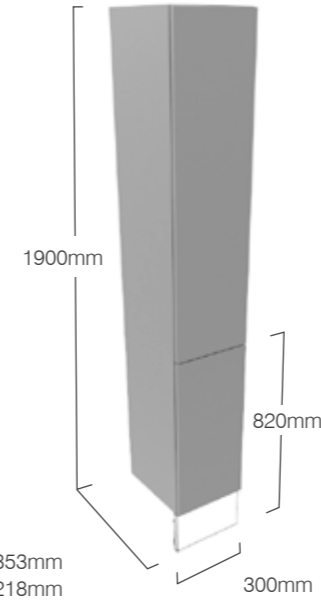

300MM STANDARD / SLIM DEPTH FULL HEIGHT TWIN DOOR CUPBOARD WITH FASCIA DOOR PACK

FEATURES

- Soft close hinges.
- Two adjustable glass shelves in top section.
- One wooden adjustable shelf in base.
- A plinth is required for this unit - see pages 138-141.

Standard depth 353mm
Slim depth 218mm

Unit Finish	Recommended Carcass		Fascia / Door Pack
	Standard Depth	Slim depth	
BURFORD			
Juniper Green	F3FHU3.D - Graphite	F2FHU3.D - Graphite	DFHU3.JNP
Coniston Blue	F3FHU3.D - Graphite	F2FHU3.D - Graphite	DFHU3.CB
Derwent Blue	F3FHU3.D - Graphite	F2FHU3.D - Graphite	DFHU3.DB
Mercury	F3FHU3.D - Graphite	F2FHU3.D - Graphite	DFHU3.MY
Chalk White	F3FHU3.OK - Natural Oak	F2FHU3.OK - Natural Oak	DFHU3.CW
Mocha	F3FHU3.OK - Natural Oak	F2FHU3.OK - Natural Oak	DFHU3.MC
Pebble Grey	F3FHU3.OK - Natural Oak	F2FHU3.OK - Natural Oak	DFHU3.PG
Slate Grey	F3FHU3.OK - Natural Oak	F2FHU3.OK - Natural Oak	DFHU3.SG
ARUBA			
Juniper Green	F3FHU3.D - Graphite	F2FHU3.D - Graphite	AFHU3.JNP
Powder Grey	F3FHU3.D - Graphite	F2FHU3.D - Graphite	AFHU3.POW
Mussel	F3FHU3.D - Graphite	F2FHU3.D - Graphite	AFHU3.MSL
Derwent Blue	F3FHU3.D - Graphite	F2FHU3.D - Graphite	AFHU3.DB
Alpine Elm	F3FHU3.D - Graphite	F2FHU3.D - Graphite	AFHU3.AE
Gloss Dark Clay	F3FHU3.D - Graphite	F2FHU3.D - Graphite	AFHU3.GDC
Mocha	F3FHU3.D - Graphite	F2FHU3.D - Graphite	AFHU3.MC
Flintwood	F3FHU3.D - Graphite	F2FHU3.D - Graphite	AFHU3.FW
White	F3FHU3.W - White	F2FHU3.W - White	AFHU3.W
VETRO			
Light Grey	F3FHU3.D - Graphite	F2FHU3.D - Graphite	VFHU3.VG
White	F3FHU3.D - Graphite	F2FHU3.D - Graphite	VFHU3.VW
	£509.50 each	£459.00 each	£174.60 each

END PANELS REQUIRED

Exposed carcass sides are covered by using colour matched end panels which will be required to complete your fitted furniture run. See pages 138-141 for panel options.

PLINTH REQUIRED

Most freestanding units require a colour matched plinth to be installed to cover any pipework underneath the units. See pages 138-141 for plinth options.

200MM WALL MOUNTED CUPBOARD - SUITABLE FOR STANDARD & SLIM DEPTH UNITS

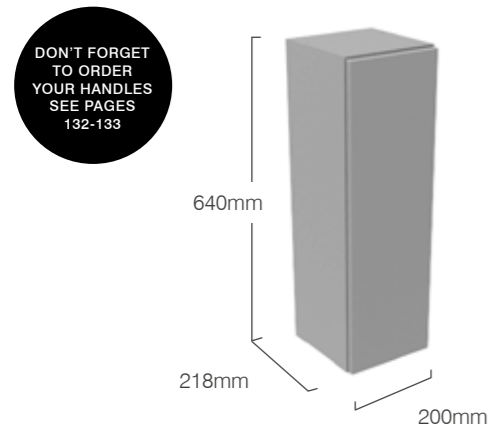

200MM WALL MOUNTED CUPBOARD WITH FASCIA DOOR PACK

FEATURES

- Soft close hinges.
- Reversible door.
- Two glass shelves.
- Concealed hangers.

* These products have plain fronted fascia packs.

Unit Finish	Recommended Carcass		Fascia / Door Pack
	Standard Depth	Slim depth	
BURFORD			
Juniper Green *	-	F2WC2.D - Graphite	FC2.JNP
Coniston Blue *	-	F2WC2.D - Graphite	FC2.CB
Derwent Blue *	-	F2WC2.D - Graphite	FC2.DB
Mercury *	-	F2WC2.D - Graphite	FC2.MY
Chalk White *	-	F2WC2.OK - Natural Oak	FC2.CW
Mocha *	-	F2WC2.OK - Natural Oak	FC2.MC
Pebble Grey *	-	F2WC2.OK - Natural Oak	FC2.PG
Slate Grey *	-	F2WC2.OK - Natural Oak	FC2.SG
ARUBA			
Juniper Green	-	F2WC2.D - Graphite	FC2.JNP
Powder Grey	-	F2WC2.D - Graphite	FC2.POW
Mussel	-	F2WC2.D - Graphite	FC2.MSL
Derwent Blue	-	F2WC2.D - Graphite	FC2.DB
Alpine Elm	-	F2WC2.D - Graphite	FC2.AE
Gloss Dark Clay	-	F2WC2.D - Graphite	FC2.GDC
Mocha	-	F2WC2.D - Graphite	FC2.MC
Flintwood	-	F2WC2.D - Graphite	FC2.FW
White	-	F2WC2.W - White	FC2.W
VETRO			
Light Grey	-	F2WC2.D - Graphite	VFC2.VG
White	-	F2WC2.D - Graphite	VFC2.VW
		£219.80 each	£69.30 each

300MM WALL MOUNTED CUPBOARD - SUITABLE FOR STANDARD & SLIM DEPTH UNITS

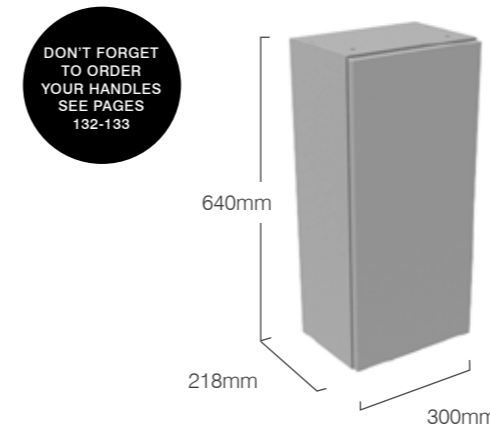

300MM WALL MOUNTED CUPBOARD WITH FASCIA DOOR PACK

FEATURES

- Soft close hinges.
- Reversible door.
- Two glass shelves.
- Concealed hangers.

Unit Finish	Recommended Carcass		Fascia / Door Pack
	Standard Depth	Slim depth	
BURFORD			
Juniper Green	-	F2WC3.D - Graphite	DFC3.JNP
Coniston Blue	-	F2WC3.D - Graphite	DFC3.CB
Derwent Blue	-	F2WC3.D - Graphite	DFC3.DB
Mercury	-	F2WC3.D - Graphite	DFC3.MY
Chalk White	-	F2WC3.OK - Natural Oak	DFC3.CW
Mocha	-	F2WC3.OK - Natural Oak	DFC3.MC
Pebble Grey	-	F2WC3.OK - Natural Oak	DFC3.PG
Slate Grey	-	F2WC3.OK - Natural Oak	DFC3.SG
ARUBA			
Juniper Green	-	F2WC3.D - Graphite	AFC3.JNP
Powder Grey	-	F2WC3.D - Graphite	AFC3.POW
Mussel	-	F2WC3.D - Graphite	AFC3.MSL
Derwent Blue	-	F2WC3.D - Graphite	AFC3.DB
Alpine Elm	-	F2WC3.D - Graphite	AFC3.AE
Gloss Dark Clay	-	F2WC3.D - Graphite	AFC3.GDC
Mocha	-	F2WC3.D - Graphite	AFC3.MC
Flintwood	-	F2WC3.D - Graphite	AFC3.FW
White	-	F2WC3.W - White	AFC3.W
VETRO			
Light Grey	-	F2WC3.D - Graphite	VFC3.VG
White	-	F2WC3.D - Graphite	VFC3.VW
		£244.00 each	£80.80 each

400MM WALL MOUNTED CUPBOARD - SUITABLE FOR STANDARD & SLIM DEPTH UNITS

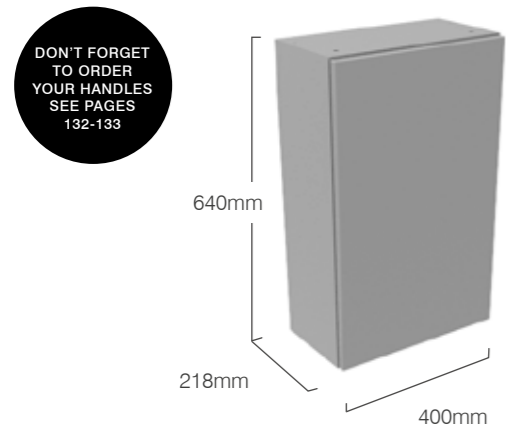

400MM WALL MOUNTED CUPBOARD WITH FASCIA DOOR PACK

FEATURES

- Soft close hinges.
- Reversible door.
- Two glass shelves.
- Concealed hangers.

Unit Finish	Recommended Carcass		Fascia / Door Pack
	Standard Depth	Slim depth	
BURFORD			
Juniper Green	-	F2WC4.D - Graphite	DFC4.JNP
Coniston Blue	-	F2WC4.D - Graphite	DFC4.CB
Derwent Blue	-	F2WC4.D - Graphite	DFC4.DB
Mercury	-	F2WC4.D - Graphite	DFC4.MY
Chalk White	-	F2WC4.OK - Natural Oak	DFC4.CW
Mocha	-	F2WC4.OK - Natural Oak	DFC4.MC
Pebble Grey	-	F2WC4.OK - Natural Oak	DFC4.PG
Slate Grey	-	F2WC4.OK - Natural Oak	DFC4.SG
ARUBA			
Juniper Green	-	F2WC4.D - Graphite	AFC4.JNP
Powder Grey	-	F2WC4.D - Graphite	AFC4.POW
Mussel	-	F2WC4.D - Graphite	AFC4.MSL
Derwent Blue	-	F2WC4.D - Graphite	AFC4.DB
Alpine Elm	-	F2WC4.D - Graphite	AFC4.AE
Gloss Dark Clay	-	F2WC4.D - Graphite	AFC4.GDC
Mocha	-	F2WC4.D - Graphite	AFC4.MC
Flintwood	-	F2WC4.D - Graphite	AFC4.FW
White	-	F2WC4.W - White	AFC4.W
VETRO			
Light Grey	-	F2WC4.D - Graphite	VFC4.VG
White	-	F2WC4.D - Graphite	VFC4.VW
		£266.60 each	£92.20 each

600MM WALL MOUNTED CUPBOARD - SUITABLE FOR STANDARD & SLIM DEPTH UNITS

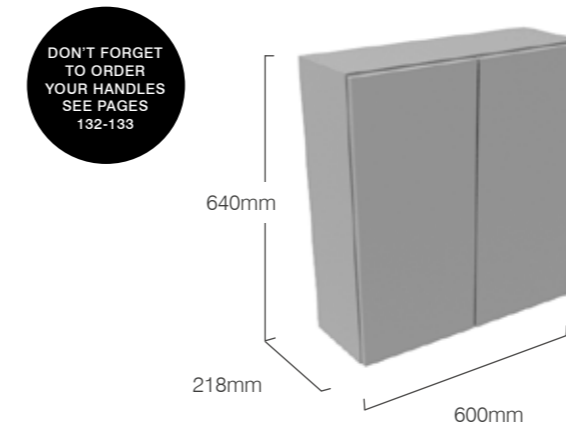

600MM WALL MOUNTED CUPBOARD WITH FASCIA DOOR PACK

FEATURES

- Soft close hinges.
- Two glass shelves.
- Concealed hangers.

Unit Finish	Recommended Carcass		Fascia / Door Pack
	Standard Depth	Slim depth	
BURFORD			
Juniper Green	-	F2WC6.D - Graphite	DFC3.JNP X2
Coniston Blue	-	F2WC6.D - Graphite	DFC3.CB X2
Derwent Blue	-	F2WC6.D - Graphite	DFC3.DB X2
Mercury	-	F2WC6.D - Graphite	DFC3.MY X2
Chalk White	-	F2WC6.OK - Natural Oak	DFC3.CW X2
Mocha	-	F2WC6.OK - Natural Oak	DFC3.MC X2
Pebble Grey	-	F2WC6.OK - Natural Oak	DFC3.PG X2
Slate Grey	-	F2WC6.OK - Natural Oak	DFC3.SG X2
ARUBA			
Juniper Green	-	F2WC6.D - Graphite	AFC3.JNP X2
Powder Grey	-	F2WC6.D - Graphite	AFC3.POW X2
Mussel	-	F2WC6.D - Graphite	AFC3.MSL X2
Derwent Blue	-	F2WC6.D - Graphite	AFC3.DB X2
Alpine Elm	-	F2WC6.D - Graphite	AFC3.AE X2
Gloss Dark Clay	-	F2WC6.D - Graphite	AFC3.GDC X2
Mocha	-	F2WC6.D - Graphite	AFC3.MC X2
Flintwood	-	F2WC6.D - Graphite	AFC3.FW X2
White	-	F2WC6.W - White	AFC3.W X2
VETRO			
Light Grey	-	F2WC6.D - Graphite	VFC3.VG X2
White	-	F2WC6.D - Graphite	VFC3.VW X2
		£339.70 each	£80.80 each

HANDLES

Handle	Finish	Code	Price
CATALINA COLOUR MATCHED HANDLE			
	<ul style="list-style-type: none"> 150mm(l) Top mounted to fascia One universal size Matrix of compatible finishes see p67 	White SCHH09W.150 £19.80 Derwent blue SCHH09DB.150 £19.80 Dark Clay SCHH09GDC.150 £19.80 Light grey SCHH09LG.150 £19.80 Carbon SCHH09MCB.150 £19.80 Juniper SCHH09JNP.150 £19.80 Black SCHH09BK.150 £19.80	

Handle	Finish	Code	Price
KANSAS			
	<ul style="list-style-type: none"> 197mm(l) 247mm(l) 297mm(l) 347mm(l) 397mm(l) 	Chrome FHKAN20.C £19.80 Chrome FHKAN25.C £23.00 Chrome FHKAN30.C £26.20 Chrome FHKAN35.C £29.40 Chrome FHKAN40.C £32.80	

Handle	Finish	Code	Price
STOCKTON CHROME			
	<ul style="list-style-type: none"> 128mm(l) 320mm(l) 492mm(l) 	Chrome SCHH04C.128 £20.30 Chrome SCHH04C.320 £26.20 Chrome SCHH04C.492 £42.40	

Handle	Finish	Code	Price
STOCKTON BLACK			
	<ul style="list-style-type: none"> 128mm(l) 320mm(l) 492mm(l) 	Black SCHH04B.128 £20.30 Black SCHH04B.320 £26.20 Black SCHH04B.492 £42.40	

Handle	Finish	Code	Price
STOCKTON BRASS			
	<ul style="list-style-type: none"> 128mm(l) 320mm(l) 492mm(l) 	Brass SCHH04A.128 £20.30 Brass SCHH04A.320 £26.20 Brass SCHH04A.492 £42.40	

Handle	Finish	Code	Price
COLUMBUS			
	<ul style="list-style-type: none"> Angular classic handle Length 174mm Hole centres 160mm 	Chrome FHCOL.C £25.80	

Handle	Finish	Code	Price
OAKLAND			
	<ul style="list-style-type: none"> Classic or contemporary handle Length 183mm Hole centres 160mm 	Chrome FHOAK.C £25.80	

Handle	Finish	Code	Price
MADISON			
	<ul style="list-style-type: none"> Length 171mm Hole centres 160mm 	Chrome FHMAD.C £25.80	

Handle	Finish	Code	Price
MONTANA CHROME			
	<ul style="list-style-type: none"> Length 110mm Hole centres 64mm 	Chrome FHMON.C £10.40	

Handle	Finish	Code	Price
MONTANA BLACK			
	<ul style="list-style-type: none"> Length 110mm Hole centres 64mm 	Black FHMON.B £10.40	

Handle	Finish	Code	Price
VERMONT			
	<ul style="list-style-type: none"> Square D-shaped handle Length 135mm Hole centres 128mm 	Chrome FHVER.C £20.30	

Handle	Finish	Code	Price
SEATTLE			
	<ul style="list-style-type: none"> D-shaped handle Length 175mm Hole centres 160mm 	Chrome FHSEA.C £25.80	

Handle	Finish	Code	Price
DETROIT			
	<ul style="list-style-type: none"> Rubberised grip to handle Length 187mm Hole centres 160mm 	Chrome FHDET.C £25.80	

Handle	Finish	Code	Price
DAYTONA			
	<ul style="list-style-type: none"> Black insert detail Length 170mm Hole centres 160mm 	Chrome FHDAY.C £25.80	

Handle	Finish	Code	Price
LEXINGTON			
	<ul style="list-style-type: none"> Crystal effect inserts x 30 Length 134mm Hole centres 128mm 	Chrome FHLEX.C £36.70	

Handle	Finish	Code	Price
FRESNO CHROME			
	<ul style="list-style-type: none"> Reeded finish Solid brass Height 35mm Diameter 35mm 	Chrome FHFRE.C £31.70	

Handle	Finish	Code	Price
FRESNO BLACK			
	<ul style="list-style-type: none"> Reeded finish Solid brass Height 35mm Diameter 35mm 	Black FHFRE.B £31.70	

Handle	Finish	Code	Price
FRESNO BRUSHED BRASS			
	<ul style="list-style-type: none"> Reeded finish Solid brass Height 35mm Diameter 35mm 	Brass FHFRE.A £31.70	

Handle	Finish	Code	Price
FRESNO BRONZE			
	<ul style="list-style-type: none"> Reeded finish Solid brass Height 35mm Diameter 35mm 	Bronze FHFRE.BR £31.70	

HANDLES

Handle	Finish	Code	Price
HUDSON CHROME			
	<ul style="list-style-type: none"> Knurled finish Solid brass Diameter 29mm Height 29mm 	Chrome FHHUD.C £25.30	

Handle	Finish	Code	Price
HUDSON BRUSHED BRASS			
	<ul style="list-style-type: none"> Knurled finish Solid brass Diameter 29mm Height 29mm 	Brass FHHUD.A £25.30	

Handle	Finish	Code	Price
HUDSON BLACK			
	<ul style="list-style-type: none"> Knurled finish Solid brass Diameter 29mm Height 29mm 	Black FHHUD.B £25.30	

Handle	Finish	Code	Price
BERKELEY CHROME			
	<ul style="list-style-type: none"> Chrome round knob Solid brass Diameter 34mm Height 31mm 	Chrome FHBER.C £31.70	

Handle	Finish	Code	Price
BERKELEY BLACK			
	<ul style="list-style-type: none"> Black round knob Solid brass Diameter 34mm Height 31mm 	Black FHBER.B £31.70	

Handle	Finish	Code	Price
BERKELEY BRUSHED BRASS			
	<ul style="list-style-type: none"> Brass round knob Solid brass Diameter 34mm Height 31mm 	Brass FHBER.A £31.70	

Handle	Finish	Code	Price
WESTPORT CHROME			
	<ul style="list-style-type: none"> Classic round knob Solid brass Diameter 33mm Height 44mm 	Chrome FHWST.C £25.30	

Handle	Finish	Code	Price
WESTPORT BLACK			
	<ul style="list-style-type: none"> Classic round knob Solid brass Diameter 33mm Height 44mm 	Black FHWST.B £25.30	

Handle	Finish	Code	Price
WESTPORT BRUSHED BRASS			
	<ul style="list-style-type: none"> Classic round knob Solid brass Diameter 33mm Height 44mm 	Brass FHWST.A £25.30	

Handle	Finish	Code	Price
WASHINGTON CHROME			
	<ul style="list-style-type: none"> Chrome button knob Diameter 32mm Height 22mm 	Chrome FHWAS.C £10.70	

Handle	Finish	Code	Price
WASHINGTON BRUSHED BRASS			
	<ul style="list-style-type: none"> Brass button knob Diameter 32mm Height 22mm 	Brass FHWAS.A £10.70	

Handle	Finish	Code	Price
WASHINGTON BLACK			
	<ul style="list-style-type: none"> Black button knob Diameter 32mm Height 22mm 	Black FHWAS.B £10.70	

Handle	Finish	Code	Price
PORTLAND CHROME			
	<ul style="list-style-type: none"> Length 32mm Length 160mm 	Chrome FHPORC.32 £10.70 Chrome FHPORC.160 £25.80	

Handle	Finish	Code	Price
PORTLAND BRUSHED BRASS			
	<ul style="list-style-type: none"> Length 32mm Length 160mm 	Brass FHPORA.32 £10.70 Brass FHPORA.160 £25.80	

Handle	Finish	Code	Price
CALDWELL			
	<ul style="list-style-type: none"> Bronze round knob Solid brass Diameter 30mm Height 30mm 	Brass FHCAL.BR £19.00	

Handle	Finish	Code	Price
HENDERSON			
	<ul style="list-style-type: none"> Classic round knob Diameter 39mm Height 26mm 	Chrome FHHEN.C £10.70	

Handle	Finish	Code	Price
RENO			
	<ul style="list-style-type: none"> Classic timeless knob Diameter 32mm Height 29mm 	Chrome FHREN.C £20.30	

WORKTOPS - STRATA SOLID SURFACE

STANDARD / SLIM DEPTH SOLID SURFACE WORKTOPS

FEATURES

- Can be cut to any size / shape.
- Supplied with front and ends factory finished.
- 3mm edge profile.
- Recommended 10mm overhang each end of worktop when choosing a length.

- * Standard worktop depth 365mm
- * Slim depth worktop depth 230mm

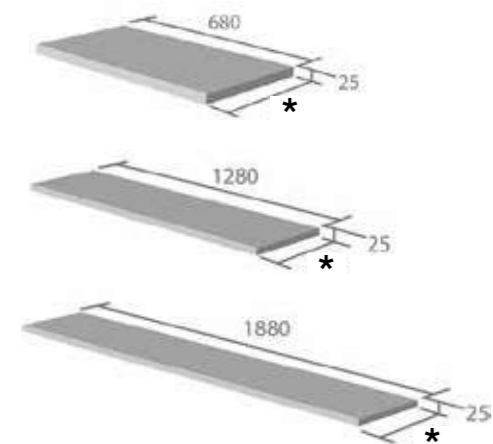

Solid Surface Worktop Finish	Standard Depth	Slim Depth
------------------------------	----------------	------------

680MM SOLID SURFACE WORKTOP - 25MM THICK		
Carrara	F3W6A.CA	F2W6A.CA
Arctic White	F3W6A.AR	F2W6A.AR
Stone Grey	F3W6A.SG	F2W6A.SG
Ice White	F3W6A.IW	F2W6A.IW
Starlight	F3W6A.SL	F2W6A.SL
Galactic Black	F3W6A.GA	F2W6A.GA
Grey Quartz	F3W6A.GQ	F2W6A.GQ

£252.00 each	£192.90 each
---------------------	---------------------

1280MM SOLID SURFACE WORKTOP - 25MM THICK		
Carrara	F3W12A.CA	F2W12A.CA
Arctic White	F3W12A.AR	F2W12A.AR
Stone Grey	F3W12A.SG	F2W12A.SG
Ice White	F3W12A.IW	F2W12A.IW
Starlight	F3W12A.SL	F2W12A.SL
Galactic Black	F3W12A.GA	F2W12A.GA
Grey Quartz	F3W12A.GQ	F2W12A.GQ

£455.80 each	£319.20 each
---------------------	---------------------

1880MM SOLID SURFACE WORKTOP - 25MM THICK		
Carrara	F3W18A.CA	F2W18A.CA
Arctic White	F3W18A.AR	F2W18A.AR
Stone Grey	F3W18A.SG	F2W18A.SG
Ice White	F3W18A.IW	F2W18A.IW
Starlight	F3W18A.SL	F2W18A.SL
Galactic Black	F3W18A.GA	F2W18A.GA
Grey Quartz	F3W18A.GQ	F2W18A.GQ

£580.50 each	£463.30 each
---------------------	---------------------

Strata Solid Surface Worktop Adhesive

STRATA 2 PART CLEAR GLUE FOR SOLID SURFACE WORKTOPS

 <ul style="list-style-type: none"> • 2 part clear glue cartridge adhesive with nozzle for Strata worktops. • Supplied with applicator - no need for specialist adhesive gun. 	FSG.CL
£54.60	

BASINS WITH INTEGRATED WORKTOPS

City Solid Surface Basin & Integrated Worktop	Finish	Code
---	--------	------

1640MM CITY SOLID SURFACE WORKTOP WITH INTEGRATED BASIN - 25MM THICK

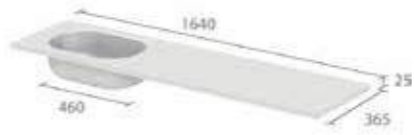
 <ul style="list-style-type: none"> • To be used with 600mm semi-countertop units only with a maximum furniture run of 1620mm including end panels. • Solid surface basin can be used left or right handed. • Can be cut to any length to suit furniture. • Undrilled to allow choice of tap position. • Integral overflow. • Recommended 10mm overhang each end of worktop when choosing a length. 	White	C3WTBAS
--	-------	---------

£833.10

Motif Solid Surface Basin & Integrated worktop	Finish	Standard Depth	Slim Depth
--	--------	----------------	------------

1640MM MOTIF STANDARD / SLIM DEPTH LEFT OR RIGHT HAND BASINS - 25MM THICK

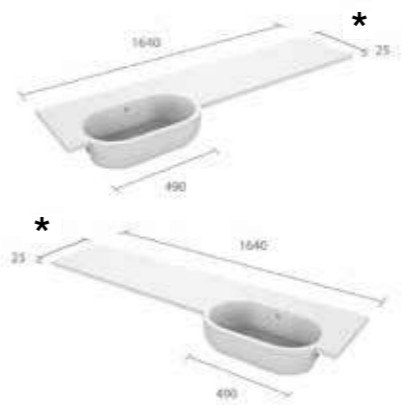
 <ul style="list-style-type: none"> • To be used with 600mm semi-countertop units only with a maximum furniture run of 1620mm including end panels. • Solid surface basin. • Left or right handed option available. • Can be cut to any length to suit furniture. • Undrilled to allow choice of tap position. • Integral overflow. • Recommended 10mm overhang each end of worktop when choosing a length. 	White White	MTF3BAS.L MTF3BAS.R	MTF2BAS.L MTF2BAS.R
--	----------------	------------------------	------------------------

- * Standard worktop depth 365mm
- * Slim depth worktop depth 230mm

£913.70 each **£741.70** each

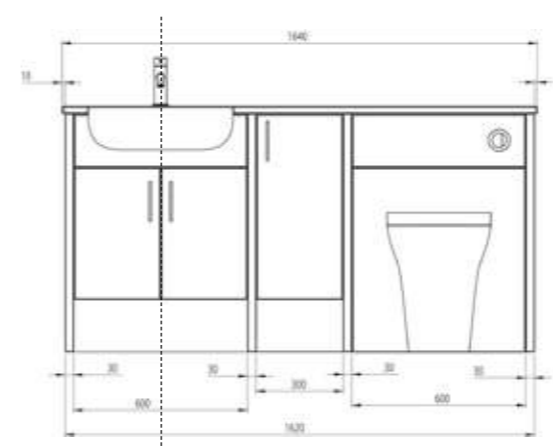

BASINS WITH INTEGRATED WORKTOPS

Motif and City basins feature integrated worktops that are 1640mm in length and designed to fit on a maximum furniture width of 1620mm, including end panels. This allows 10mm overhang at each end.

It is also critical that the basin bowl is positioned centrally on the semi-countertop furniture unit.

Please check carefully that your furniture selection will fit.

Overflow Trims	Finish	Code
----------------	--------	------

 <ul style="list-style-type: none"> • Coordinate with brassware and handles. • Chrome trims are provided as standard. 	<ul style="list-style-type: none"> * White * Black * Brushed Brass 	OVC22WT OVMCBK OVMCA
* Specify at time of ordering		£10.00 each

WORKTOPS - COMPACT GRADE LAMINATES (CGL)

Discover our selection of super hardwearing, compact grade laminate worktops. These worktops boast an impact and scratch resistant surface made from hygienic, fully waterproof material, making them a perfect, low maintenance option for the busy family bathroom. Available in three chic finishes, with a slim 12mm profile. Compact grade laminate worktops can also be cut to any length, without the need to reseal.

Exclusively designed to work with our 600mm underslung basin unit (page 118).



CGL Laminate Worktop Finish	Finish	Code	PRICE
-----------------------------	--------	------	-------

1310MM CGL WORKTOP - 12MM THICK			
	<ul style="list-style-type: none"> Pre-cut aperture for underslung basin. Can be cut to desired length. Recommended 10mm overhang each end of worktop. 12mm thickness with 2mm soft chamfered edge. Only compatible with 600mm Standard Depth Underslung carcass – see page 118. Can be turned through 180 degrees to have left or right handed basin. 	Grey Slate White Slate Concrete	F3W13CS.GS £453.60 F3W13CS.WT £453.60 F3W13CS.CN £453.60

1640MM CGL WORKTOP - 12MM THICK			
	<ul style="list-style-type: none"> Pre-cut aperture for underslung basin. Can be cut to desired length. Recommended 10mm overhang each end of worktop. 12mm thickness with 2mm soft chamfered edge. Only compatible with 600mm Standard Depth Underslung carcass – see page 118. Can be turned through 180 degrees to have left or right handed basin. 	Grey Slate White Slate Concrete	F3W16CS.GS £596.60 F3W16CS.WT £596.60 F3W16CS.CN £596.60

STRATA 600 UNDERSLUNG BASIN INC FIXINGS			
	<ul style="list-style-type: none"> To be used with standard depth 600mm underslung units only. Solid surface basin. Integral overflow. Includes fixings and instructions for worktop fitting. 	White	CGL3BAS £283.80

Overflow Trims	Finish	Code
----------------	--------	------

OVERFLOW TRIMS		
<ul style="list-style-type: none"> Coordinate with brassware and handles. Chrome trims are provided as standard. <p>* Specify at time of ordering</p>	<ul style="list-style-type: none"> * White * Black * Brushed Brass 	OVC22WT OVMCBK OVMCA
£10.00 each		

WORKTOPS - LAMINATE

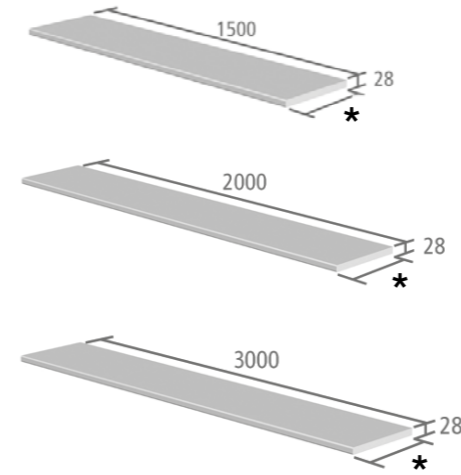

STANDARD / SLIM DEPTH LAMINATE WORKTOPS

FEATURES

- 28mm thickness with a 6mm edge radius.
- Edge banded both ends and supplied with extra edge banding to use when cut down.
- Sealed under front profile to prevent water ingress.
- Recommended 10mm overhang each end of worktop when choosing a length.

- * Standard worktop depth 365mm
- * Slim depth worktop depth 230mm

Laminate Worktop Finish	Standard Depth		Slim Depth	
1500MM LAMINATE WORKTOP - 28MM THICK	CODE	PRICE	CODE	PRICE
Massa Marble	F3W15.MM	£145.60	F2W15.MM	£122.00
Portland Stone	F3W15.PS	£145.60	F2W15.PS	£122.00
Gloss White	F3W15.W	£145.60	F2W15.W	£122.00
Black Granite	F3W15.BG	£145.60	F2W15.BG	£122.00
Riven Slate	F3W15.SL	£145.60	F2W15.SL	£122.00
Isadora Stone	F3W15.IS	£145.60	F2W15.IS	£122.00
Natural Oak	F3W15.OK	£145.60	F2W15.OK	£122.00
White Sparkle	F3W15.WS	£159.10	F2W15.WS	£134.90
Black Sparkle	F3W15.BS	£159.10	F2W15.BS	£134.90

2000MM LAMINATE WORKTOP - 28MM THICK	CODE	PRICE	CODE	PRICE
Massa Marble	F3W20.MM	£178.90	F2W20.MM	£156.40
Portland Stone	F3W20.PS	£178.90	F2W20.PS	£156.40
Gloss White	F3W20.W	£178.90	F2W20.W	£156.40
Black Granite	F3W20.BG	£178.90	F2W20.BG	£156.40
Riven Slate	F3W20.SL	£178.90	F2W20.SL	£156.40
Isadora Stone	F3W20.IS	£178.90	F2W20.IS	£156.40
Natural Oak	F3W20.OK	£178.90	F2W20.OK	£156.40
White Sparkle	F3W20.WS	£197.20	F2W20.WS	£172.50
Black Sparkle	F3W20.BS	£197.20	F2W20.BS	£172.50

3000MM LAMINATE WORKTOP - 28MM THICK	CODE	PRICE	CODE	PRICE
Massa Marble	F3W30.MM	£363.30	-	-
Portland Stone	F3W30.PS	£363.30	-	-
White Sparkle	F3W30.WS	£363.30	-	-
Black Sparkle	F3W30.BS	£363.30	-	-
Gloss White	F3W30.W	£363.30	-	-
Black Granite	F3W30.BG	£363.30	-	-
Riven Slate	F3W30.SL	£363.30	-	-
Isadora Stone	F3W30.IS	£363.30	-	-
Natural Oak	F3W30.OK	£363.30	-	-

18MM FILLER / CLAD-ON END PANELS



18MM STANDARD / SLIM DEPTH FILLER CLAD-ON END PANELS

FEATURES

- Full edged.
- Can be cut to suit different installations.
- Use for colour matched end panels.
- When more than one filler panel between units we recommend cutting in half for cost efficiency.

* Burford end panels have feature tongue & groove effect.

When creating a 'framed' look, cutting 1 x standard depth end panel in half saves on material and on overall cost. These 2 half depth panels (A & B) can be installed between units.

Standard Depth End Panel

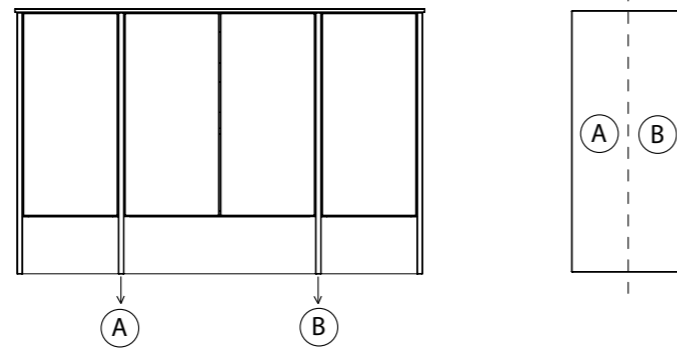

Filler Clad-On Panel Finish	Standard Depth		Slim Depth	
	CODE	PRICE	CODE	PRICE
BURFORD				
Juniper Green *	DF3P8.JNP	£106.70	DF2P8.JNP	£91.50
Coniston Blue *	DF3P8.CB	£106.70	DF2P8.CB	£91.50
Derwent Blue *	DF3P8.DB	£106.70	DF2P8.DB	£91.50
Mercury *	DF3P8.MY	£106.70	DF2P8.MY	£91.50
Chalk White *	DF3P8.CW	£106.70	DF2P8.CW	£91.50
Mocha *	DF3P8.MC	£106.70	DF2P8.MC	£91.50
Pebble Grey *	DF3P8.PG	£106.70	DF2P8.PG	£91.50
Slate Grey *	DF3P8.SG	£106.70	DF2P8.SG	£91.50
ARUBA				
Juniper Green	F3P8.JNP	£89.30	F2P8.JNP	£91.50
Powder Grey	F3P8.POW	£89.30	F2P8.POW	£91.50
Mussel	F3P8.MSL	£89.30	F2P8.MSL	£91.50
Derwent Blue	F3P8.DB	£89.30	F2P8.DB	£76.20
Alpine Elm	F3P8.AE	£89.30	F2P8.AE	£76.20
Gloss Dark Clay	F3P8.GDC	£89.30	F2P8.GDC	£76.20
Mocha	F3P8.MC	£89.30	F2P8.MC	£76.20
Flintwood	F3P8.FW	£89.30	F2P8.FW	£76.20
White	F3P8.W	£89.30	F2P8.W	£76.20
VETRO				
Light Grey	VF3P8.VG	£89.30	VF2P8.VG	£76.20
White	VF3P8.VW	£89.30	VF2P8.VW	£76.20

18MM TALL FILLER / CLAD-ON END PANELS

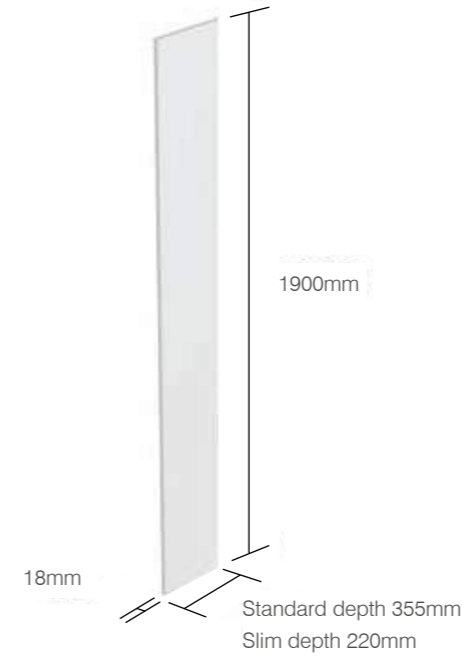

18MM TALL STANDARD / SLIM DEPTH FILLER CLAD-ON END PANELS

FEATURES

- Full edged.
- Can be cut to suit different installations.
- Use for colour matched end panels.
- When more than one filler panel between units we recommend cutting in half for cost efficiency.

* Burford end panels have feature tongue & groove effect.

When creating a 'framed' look, cutting 1 x standard depth end panel in half saves on material and on overall cost. These 2 half depth panels (A & B) can be installed between units.

Standard Depth End Panel

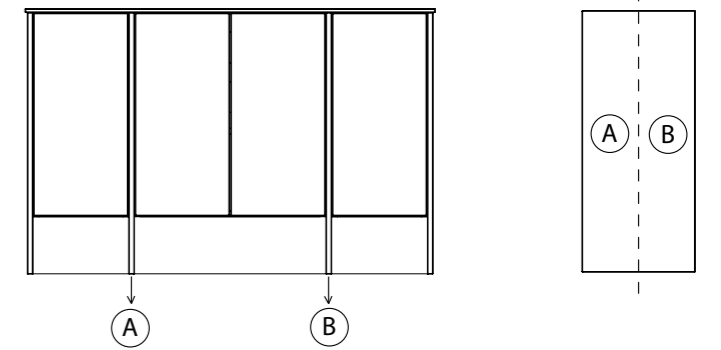

Tall Filler Clad-On Panel Finish	Standard Depth		Slim Depth	
	CODE	PRICE	CODE	PRICE
BURFORD				
Juniper Green *	DF3TP19.JNP	£192.90	DF2TP19.JNP	£184.30
Coniston Blue *	DF3TP19.CB	£192.90	DF2TP19.CB	£184.30
Derwent Blue *	DF3TP19.DB	£192.90	DF2TP19.DB	£184.30
Mercury *	DF3TP19.MY	£192.90	DF2TP19.MY	£184.30
Chalk White *	DF3TP19.CW	£192.90	DF2TP19.CW	£184.30
Mocha *	DF3TP19.MC	£192.90	DF2TP19.MC	£184.30
Pebble Grey *	DF3TP19.PG	£192.90	DF2TP19.PG	£184.30
Slate Grey *	DF3TP19.SG	£192.90	DF2TP19.SG	£184.30
ARUBA				
Juniper Green	F3TP19.JNP	£164.40	F2TP19.JNP	£139.70
Powder Grey	F3TP19.POW	£164.40	F2TP19.POW	£139.70
Mussel	F3TP19.MSL	£164.40	F2TP19.MSL	£139.70
Derwent Blue	F3TP19.DB	£164.40	F2TP19.DB	£139.70
Alpine Elm	F3TP19.AE	£164.40	F2TP19.AE	£139.70
Gloss Dark Clay	F3TP19.GDC	£164.40	F2TP19.GDC	£139.70
Mocha	F3TP19.MC	£164.40	F2TP19.MC	£139.70
Flintwood	F3TP19.FW	£164.40	F2TP19.FW	£139.70
White	F3TP19.W	£164.40	F2TP19.W	£139.70
VETRO				
Light Grey	VF3TP19.VG	£164.40	VF2TP19.VG	£139.70
White	VF3TP19.VW	£164.40	VF2TP19.VW	£139.70

DESIGN / CLAD-ON END PANELS



STANDARD / SLIM DEPTH DESIGN CLAD-ON END PANEL

FEATURES

- Clad on to units to create striking effects.
- Allows creation of a framed inset door look.
- Use with standard and slim depth base units.
- Cut down for wall-hung base unit installations
- When more than one filler panel between units we recommend cutting in half for cost efficiency.

Thickness of clad-on panels varies according to finish. Please see below.

25mm thickness

28mm thickness

30mm thickness

- * Burford end panels have feature tongue & groove effect.

When creating a 'framed' look, cutting 1 x standard depth end panel in half saves on material and on overall cost. These 2 half depth panels (A & B) can be installed between units.

Standard Depth End Panel

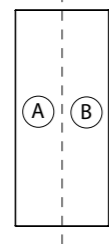
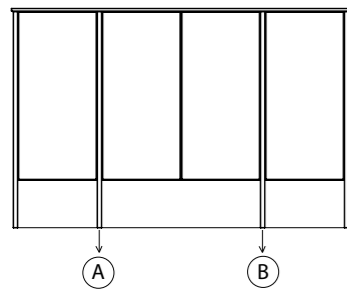

Design Clad-On End Panel Finish	Standard Depth		Slim Depth	
BURFORD	CODE	PRICE	CODE	PRICE
Juniper Green - 30mm thickness *	DF3APJNP	£153.10	DF2APJNP	£110.70
Coniston Blue - 30mm thickness *	DF3APCB	£153.10	DF2APCB	£110.70
Derwent Blue - 30mm thickness *	DF3APDB	£153.10	DF2APDB	£110.70
Mercury - 30mm thickness *	DF3APMY	£153.10	DF2APMY	£110.70
Chalk White - 30mm thickness *	DF3APCW	£153.10	DF2APCW	£110.70
Mocha - 30mm thickness *	DF3APMC	£153.10	DF2APMC	£110.70
Pebble Grey - 30mm thickness *	DF3APPG	£153.10	DF2APPG	£110.70
Slate Grey - 30mm thickness *	DF3APSG	£153.10	DF2APSG	£110.70
ARUBA				
Juniper Green - 30mm thickness	F3APJNP	£127.30	F2APJNP	£92.20
Powder Grey - 30mm thickness	F3APPOW	£127.30	F2APPOW	£92.20
Mussel - 30mm thickness	F3APMSL	£127.30	F2APMSL	£92.20
Derwent Blue - 30mm thickness	F3APDB	£127.30	F2APDB	£92.20
Alpine Elm - 25mm thickness	F3APAE	£127.30	F2APAE	£92.20
Gloss Dark Clay - 30mm thickness	F3APGDC	£127.30	F2APGDC	£92.20
Mocha - 30mm thickness	F3APMC	£127.30	F2APMC	£92.20
Flintwood - 28mm thickness	F3APFW	£127.30	F2APFW	£92.20
White - 30mm thickness	F3APW	£127.30	F2APW	£92.20
VETRO				
Light Grey - 30mm thickness	VF3APVG	£127.30	VF2APVG	£92.20
White - 30mm thickness	VF3APVW	£127.30	VF2APVW	£92.20

PLINTHS

1000MM, 1500MM & 2000MM PLINTHS

FEATURES

- 1000mm, 1500mm & 2000mm length - cut to size.
- Fully edged.
- * Burford plinths have a horizontal rail to create a framed look in combination with end / filler panels.

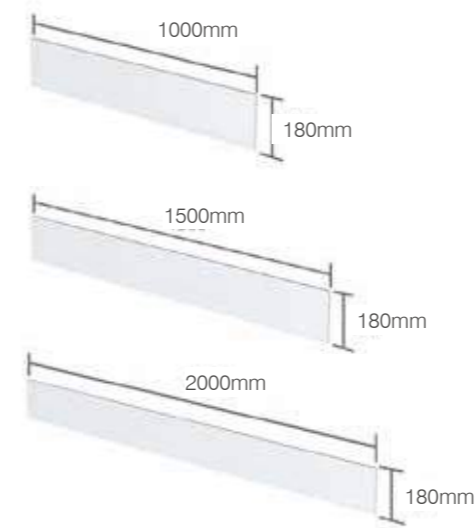

Plinth Finish	1000mm Plinth		1500mm Plinth		2000mm Plinth	
BURFORD	CODE	PRICE	CODE	PRICE	CODE	PRICE
Juniper Green *	DFPL10.JNP	£96.40	DFPL15.JNP	£130.60	DFPL20.JNP	£153.10
Coniston Blue *	DFPL10.CB	£96.40	DFPL15.CB	£130.60	DFPL20.CB	£153.10
Derwent Blue *	DFPL10.DB	£96.40	DFPL15.DB	£130.60	DFPL20.DB	£153.10
Mercury *	DFPL10.MY	£96.40	DFPL15.MY	£130.60	DFPL20.MY	£153.10
Chalk White *	DFPL10.CW	£96.40	DFPL15.CW	£130.60	DFPL20.CW	£153.10
Mocha *	DFPL10.MC	£96.40	DFPL15.MC	£130.60	DFPL20.MC	£153.10
Pebble Grey *	DFPL10.PG	£96.40	DFPL15.PG	£130.60	DFPL20.PG	£153.10
Slate Grey *	DFPL10.SG	£96.40	DFPL15.SG	£130.60	DFPL20.SG	£153.10
ARUBA						
Juniper Green	FPL10.JNP	£79.40	FPL15.JNP	£92.20	FPL20.JNP	£119.30
Powder Grey	FPL10.POW	£79.40	FPL15.POW	£92.20	FPL20.POW	£119.30
Mussel	FPL10.MSL	£79.40	FPL15.MSL	£92.20	FPL20.MSL	£119.30
Derwent Blue	FPL10.DB	£79.40	FPL15.DB	£96.40	FPL20.DB	£119.30
Alpine Elm	FPL10.AE	£79.40	FPL15.AE	£96.40	FPL20.AE	£119.30
Gloss Dark Clay	FPL10.GDC	£79.40	FPL15.GDC	£96.40	FPL20.GDC	£119.30
Mocha	FPL10.MC	£79.40	FPL15.MC	£96.40	FPL20.MC	£119.30
Flintwood	FPL10.FW	£79.40	FPL15.FW	£96.40	FPL20.FW	£119.30
White	FPL10.W	£79.40	FPL15.W	£96.40	FPL20.W	£119.30
VETRO						
Light Grey	FPL10.VG	£79.40	VFPL15.VG	£96.40	VFPL20.VG	£119.30
White	FPL10.VW	£79.40	VFPL15.VW	£96.40	VFPL20.VW	£119.30

BATH PANELS & CORNER POSTS

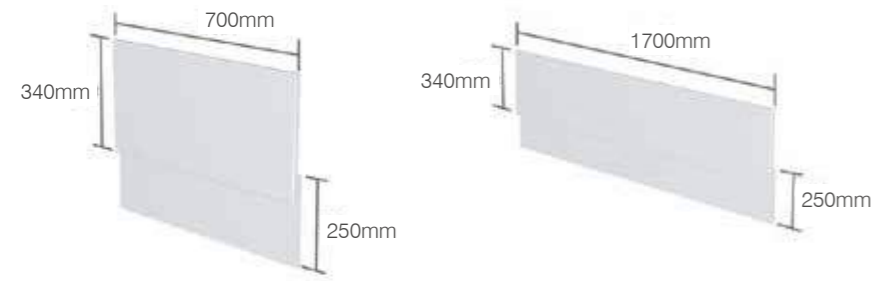

700MM & 1700MM BATH PANELS

FEATURES

- Nominal height from underside of bath to floor 520mm, this gives plinth height of 180mm to match furniture.
- Plinth can be screwed to panel from rear.
- Maximum height 570mm.

Bath Panel Finish	700mm Bath Panel	1700mm Bath Panel
BURFORD	CODE	CODE
Juniper Green	FBP7.JNP	FBP17.JNP
Coniston Blue	FBP7.CB	FBP17.CB
Derwent Blue	FBP7.DB	FBP17.DB
Mercury	FBP7.MY	FBP17.MY
Chalk White	FBP7.CW	FBP17.CW
Mocha	FBP7.MC	FBP17.MC
Pebble Grey	FBP7.PG	FBP17.PG
Slate Grey	FBP7.SG	FBP17.SG
ARUBA		
Juniper Green	FBP7.JNP	FBP17.JNP
Powder Grey	FBP7.POW	FBP17.POW
Mussel	FBP7.MSL	FBP17.MSL
Derwent Blue	FBP7.DB	FBP17.DB
Alpine Elm	FBP7.AE	FBP17.AE
Gloss Dark Clay	FBP7.GDC	FBP17.GDC
Mocha	FBP7.MC	FBP17.MC
Flintwood	FBP7.FW	FBP17.FW
White	FBP7.W	FBP17.W
VETRO		
Light Grey	FBP7.VG	FBP17.VG
White	FBP7.VW	FBP17.VW
	£132.20 each	£331.10 each

Bath Panel Corner Posts	Finish	Code																								
CORNER POSTS																										
<ul style="list-style-type: none"> Use on ends of bath panels to increase length of panel from 1700mm to 17500mm, 1800mm etc to suit different bath sizes. Allows neat joint between front and end panels. Cut to height of bath. 	<table border="1"> <tbody> <tr><td>Juniper Green</td><td>FBCP6.JNP</td></tr> <tr><td>Powder Grey</td><td>FBCP6.POW</td></tr> <tr><td>Mussel</td><td>FBCP6.MSL</td></tr> <tr><td>Coniston Blue</td><td>FBCP6.CB</td></tr> <tr><td>Derwent Blue</td><td>FBCP6.DB</td></tr> <tr><td>Mercury</td><td>FBCP6.MY</td></tr> <tr><td>Chalk White</td><td>FBCP6.CW</td></tr> <tr><td>Mocha</td><td>FBCP6.MC</td></tr> <tr><td>Pebble Grey</td><td>FBCP6.PG</td></tr> <tr><td>Slate Grey</td><td>FBCP6.SG</td></tr> <tr><td>Gloss Dark Clay</td><td>FBCP6.GDC</td></tr> <tr><td>White</td><td>FBCP6.W</td></tr> </tbody> </table>	Juniper Green	FBCP6.JNP	Powder Grey	FBCP6.POW	Mussel	FBCP6.MSL	Coniston Blue	FBCP6.CB	Derwent Blue	FBCP6.DB	Mercury	FBCP6.MY	Chalk White	FBCP6.CW	Mocha	FBCP6.MC	Pebble Grey	FBCP6.PG	Slate Grey	FBCP6.SG	Gloss Dark Clay	FBCP6.GDC	White	FBCP6.W	
Juniper Green	FBCP6.JNP																									
Powder Grey	FBCP6.POW																									
Mussel	FBCP6.MSL																									
Coniston Blue	FBCP6.CB																									
Derwent Blue	FBCP6.DB																									
Mercury	FBCP6.MY																									
Chalk White	FBCP6.CW																									
Mocha	FBCP6.MC																									
Pebble Grey	FBCP6.PG																									
Slate Grey	FBCP6.SG																									
Gloss Dark Clay	FBCP6.GDC																									
White	FBCP6.W																									
	£83.40 each																									

SANITARYWARE

Back To Wall & Wall Hung WCs & Toilet Seats	Finish	Code	Price
PARADIGM BACK TO WALL WC (EXCLUDING TOILET SEAT)			
<ul style="list-style-type: none"> 490mm Projection Horizontal Outlet Concealed fixings for anchoring to floor Top fix design for use with Paradigm toilet seat (sold separately) Rimless 	White	PBWPN	£275.20
PARADIGM WALL HUNG WC (EXCLUDING TOILET SEAT)			
<ul style="list-style-type: none"> 490mm projection. Horizontal outlet. Top fix design for use with Cover soft close toilet seat (sold separately). Must be mounted on specialist fixing frame - See page 148. Rimless. 	White	PWHPAN	£275.20
PARADIGM SOFT CLOSE TOILET SEAT			
<ul style="list-style-type: none"> Soft close. Lift off quick release. Top fix seat design. Thermoset seat. Wrap over design. 	White	DC14030	£102.80
ACCENT 510MM BACK TO WALL WC (EXCLUDING TOILET SEAT)			
<ul style="list-style-type: none"> 510mm projection. Horizontal outlet. Concealed fixings for anchoring to floor. Top fix design for use with Accent soft close toilet seat (sold separately). Rimless. 	White	ABWPAN	£459.00
ACCENT 505MM WALL HUNG WC (EXCLUDING TOILET SEAT)			
<ul style="list-style-type: none"> 505mm projection. Horizontal outlet. Top fix design for use with Accent soft close toilet seat (sold separately). Must be mounted on specialist fixing frame - See page 148. Rimless. 	White	AWHPAN	£459.00
ACCENT SOFT CLOSE TOILET SEAT			
<ul style="list-style-type: none"> Soft Close. Quick Release. Top fix seat design. Thermoset seat. Wrap over design. 	White	ASCTS	£109.10

SANITARYWARE

Back To Wall & Wall Hung WCs & Toilet Seats	Finish	Code	Price
ACCENT SOFT CLOSE TOILET SEAT			
 <ul style="list-style-type: none"> Soft Close. Quick Release. Top fix seat design. Thermoset seat. Wrap over design. 	White	ASCTS	£109.10
COVER 530MM BACK TO WALL WC (EXCLUDING TOILET SEAT)			
 <ul style="list-style-type: none"> 530mm projection. Horizontal outlet. Concealed fixings for anchoring to floor. Top fix design for use with Cover soft close toilet seat (sold separately). Rimless. 	White	CBWPAN-R	£459.00
COVER 525MM WALL HUNG WC (EXCLUDING TOILET SEAT)			
 <ul style="list-style-type: none"> 525mm projection. Horizontal outlet. Top fix design for use with Cover soft close toilet seat (sold separately). Must be mounted on specialist fixing frame - See page 148. Rimless. 	White	CWHPAN-R	£459.00
COVER SOFT CLOSE TOILET SEAT			
 <ul style="list-style-type: none"> Soft Close. Quick Release. Top fix seat design. Thermoset seat. Wrap over design. 	White	CSCTS	£109.10
HARROW 520MM BACK TO WALL WC (EXCLUDING TOILET SEAT)			
 <ul style="list-style-type: none"> 520mm projection. Horizontal outlet. Top fix design for use with the Harrow seat (shown). Concealed fixings for anchoring to floor. 	White	BTW850S	£251.50
HARROW SOFT CLOSE TOILET SEAT			
 <ul style="list-style-type: none"> Suitable for use with Harrow back to wall WC. Top fix or under fix. High gloss white painted wooden seat. Chrome soft close bar hinge. 	White	HSCTSW	£122.00
NOTE 500MM BACK TO WALL WC (EXCLUDING TOILET SEAT)			
 <ul style="list-style-type: none"> 500mm projection. Horizontal outlet. Top fix seat design. Concealed fixings for anchoring to floor. 	White	NBWPAN	£553.60



SANITARYWARE

Back To Wall & Wall Hung WCs & Toilet Seats	Finish	Code	Price
NOTE 500MM WALL HUNG WC (EXCLUDING TOILET SEAT)			
 <ul style="list-style-type: none"> 500mm projection. Horizontal outlet. Must be mounted on specialist fixing frame - See page 148. Concealed fixings with 180mm spaced fixing centres. 	White	NWHPAN	£553.60
NOTE SOFT CLOSE TOILET SEAT			
 <ul style="list-style-type: none"> Suitable for use with Note back to wall and wall hung WCs. Top fix, soft close, quick release hinges. Thermoset seat. Wrap over style. Anti-bacterial protection. 	White	8704WSC	£80.40
NOTE SLIM SOFT CLOSE TOILET SEAT			
 <ul style="list-style-type: none"> Suitable for use with Note back to wall and wall hung WCs. Top fix, soft close, quick release hinges. Thermoset seat. Slim seat design. Anti-bacterial protection. Upgrade your seat cover caps to black. See page 81. 	White	NSLSCTS	£116.60
ZEST 500MM BACK TO WALL WC			
 <ul style="list-style-type: none"> 500mm projection. Horizontal outlet. Top fix design for use with Zest 500mm toilet seat (sold separately). Concealed fixings for anchoring to floor. 	White	ZBWPAN50	£403.10
ZEST 500MM WALL HUNG WC			
 <ul style="list-style-type: none"> 500mm projection. Horizontal outlet. Top fix design for use with Zest 500mm toilet seat (sold separately). Concealed fixings with 180mm spaced fixing centres. Must be mounted on specialist fixing frame - See page 148. 	White	ZWHPAN50	£443.90
ZEST 500MM SOFT CLOSE TOILET SEAT			
 <ul style="list-style-type: none"> Suitable for use with - 500mm Zest back to wall and wall hung WCs and Zest close coupled WC. Top fix design. Thermoset seat. Wrap over style. Chrome soft close hinges. 	White	ZSCTS50	£197.80

SANITARYWARE

Back To Wall & Wall Hung WCs & Toilet Seats	Finish	Code	Price
ZEST 450MM SHORT PROJECTION BACK TO WALL WC			
 <ul style="list-style-type: none"> 450mm ultra short projection. Horizontal outlet. Top fix design for use with Zest 450mm toilet seat (sold separately). Concealed fixings for anchoring to floor. 	White	ZBWPAN45	£376.20
ZEST 450MM SHORT PROJECTION SOFT CLOSE TOILET SEAT			
 <ul style="list-style-type: none"> Suitable for use with 450mm Zest short projection back to wall WC. Top fix design. Thermoset seat. Wrap over style. Chrome soft close hinges. Quick release. 	White	ZSCTS45	£197.80
GEO 505MM BACK TO WALL WC			
 <ul style="list-style-type: none"> 505mm projection. Horizontal outlet. Top fix design for use with Geo 505mm toilet seat (sold separately). 	White	GBWPAN	£281.60
GEO SOFT CLOSE TOILET SEAT			
 <ul style="list-style-type: none"> Suitable for use with Geo back to wall WC and Geo close coupled WC. Top fix design. Thermoset seat. Quick release. Secure fix technology. Secure-Fix QR 	White	GSCTS-SF	£108.00
Close Coupled WCs	Finish	Code	Price
PARADIGM CLOSE COUPLED FULLY ENCLOSED WC			
 <ul style="list-style-type: none"> 640mm projection. Top fix design for use with Paradigm toilet seat (sold separately). Concealed fixings for anchoring to floor. 5/3L flush. Cistern Fittings supplied with air gap technology. See page 143 for soft close seat. 	White	PCCPAN DC14035	£316.00 £105.70
			£421.70
PARADIGM CLOSE COUPLED OPEN BACK WC			
 <ul style="list-style-type: none"> 640mm projection. Top fix design for use with Paradigm toilet seat (sold separately). Concealed fixings for anchoring to floor. 5/3L flush. Cistern Fittings supplied with air gap technology. See page 143 for soft close seat. 	White	PCCPAN2 DC14035	£285.90 £105.70
			£391.60

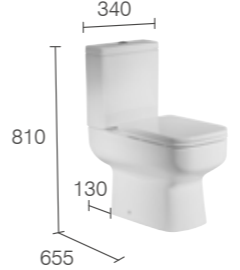





SANITARYWARE

Close Coupled WCs	Finish	Code	Price
HARROW CLOSE COUPLED WC			
 <ul style="list-style-type: none"> 705mm Projection. Dual flush 6/4L. Ceramic flush lever (lift up for reduced flush). Use with Harrow wooden soft close seat. Thermoset soft close quick release seat. Cistern Fittings supplied with air gap technology. See page 144 for soft close seat. 	White	HCCPAN HCCTNK	£199.90 £165.00
			£680.90
Close Coupled WCs With Contactless Flush	Finish	Code	Price
GEO CLOSE COUPLED WC WITH CONTACTLESS FLUSH			
 <ul style="list-style-type: none"> 655mm projection. Top fix design for use with Geo toilet seat (sold separately). Concealed fixings for anchoring to floor. 130mm side void. 6/4L flush. Cistern Fittings supplied with air gap technology. See page 146 for soft close seat. 	White	GCCPAN2 GCCTNK-SEN	£336.40 £268.70
			£605.10
GEO CLOSE COUPLED FULLY ENCLOSED WC WITH CONTACTLESS FLUSH			
 <ul style="list-style-type: none"> 655mm projection. Top fix design for use with Geo toilet seat (sold separately). Concealed fixings for anchoring to floor. 6/4L flush. Cistern Fittings supplied with air gap technology. See page 146 for soft close seat. 	White	GCCPAN GCCTNK-SEN	£370.80 £268.70
			£639.50
COVER 660MM CLOSE COUPLED FULLY ENCLOSED WC WITH CONTACTLESS FLUSH			
 <ul style="list-style-type: none"> 660mm projection. Dual flush fittings included. Top fix design for use with Cover toilet seat (sold separately). 6/3L flush. Cistern Fittings supplied with air gap technology. Rimless. See page 144 for soft close seat. 	White	CCCPAN-R CCCTNK-R-SEN	£459.00 £335.40
			£794.40















SANITARYWARE

Wall Hung Frames	Finish	Code	Price
0.82M WALL HUNG WC FRAME - FOR USE WITH FURNITURE INSTALLATIONS			
 <ul style="list-style-type: none"> 0.82m high to enable use within 600mm & wider furniture WC units. 500mm width, 167-215mm adjustable depth 6/3L pneumatic flush valve and side entry 1/2" (female) inlet valve. Top & front access options. Polystyrene anti condensation jacket. 0.2-10bar working pressure range. Brackets, fixings & 1st fix protective covers included. Requires flush plate/button/contactless sensor. See page 85. 	-	TR9005	£322.50
FURNITURE ADAPTER KIT FOR 0.82M WALL HUNG WC FRAME			
<ul style="list-style-type: none"> Use with the 0.82m Wall Hung WC Frame when in furniture installations. 	-	TR9007	£55.20
1.0M WALL HUNG WC FRAME - FOR USE WITH FURNITURE INSTALLATIONS			
 <ul style="list-style-type: none"> 1.0m high for in-wall applications. 500mm width, 167-215mm under window adjustable depth. 6/3L pneumatic flush valve and side entry 1/2" (female) inlet valve. Top & front access options. Polystyrene anti condensation jacket. 0.2-10bar working pressure range. Brackets, fixings & 1st fix protective covers included. Requires flush plate/button/contactless sensor. See page 85. 	-	TR9015	£322.50
1.17M WALL HUNG WC FRAME - FOR USE WITH FURNITURE INSTALLATIONS			
 <ul style="list-style-type: none"> 1.17m high for in-wall applications. 500mm width, 140-200mm adjustable depth. 6/3L pneumatic flush valve & top entry 1/2" (male) inlet valve. Front access. Polystyrene anti condensation jacket. 0.2-10bar working pressure range. Brackets, fixings & 1st fix protective covers included. Requires flush plate/button/contactless sensor. See page 85. 	-	TR9006	£322.50
0.4M HALF HEIGHT			
 <ul style="list-style-type: none"> 0.4m high compact WC frame. Only 400mm wide, so it is suitable for narrow 500mm back to wall unit applications. Can also be used for bidets. Compatible with both slim & standard depth furniture. For use with Torrent, Cascade or comfort height cisterns. See page 87. 	-	TR9018	£149.40

SANITARYWARE

Cisterns	Finish	Code	Price
IN-WALL CISTERN			
 <ul style="list-style-type: none"> Ideal for fully tiled in installations. All parts serviceable through flush plate aperture. Internal isolation valve. 150mm height adjustment. Top or front flush plate mounting. Dual flush (6/3 litres). Pneumatic flush valve. Side entry inlet valve (1/2" female BSP). Push plate or contactless sensor required see page 85. 	-	TR9009	£147.80
TORRENT CONCEALED DUAL FLUSH CISTERN			
 <ul style="list-style-type: none"> Bottom entry. Dual flush (6/3 litres). Chrome effect pneumatic button included or use with optional push button/push plate or contactless sensor see page 85. Water supply connection at bottom left: 1/2" BSP. 	-	TR9001	£130.00
CASCADE CONCEALED DUAL FLUSH CISTERN			
 <ul style="list-style-type: none"> Side entry. Dual flush (6/3 litres). Chrome effect pneumatic button included or use with optional push button/flush plate or contactless sensor see page 85. Water supply connection at side left: 1/2" BSP. 	-	TR9002	£130.00
COMFORT HEIGHT CISTERN			
 <ul style="list-style-type: none"> Comfort Height cistern Developed specifically to allow comfort height back to wall pans to be used in 820mm high furniture Dual flush (6/3 litres). Pneumatic flush valve. Bottom entry inlet valve. Chrome effect pneumatic button included or use with optional square push button or contactless sensor see page 85. Not compatible with flush plates. 	-	TR9008	£130.00

SANITARYWARE

Flushing Options	Finish	Code	Price
GLASS FLUSH PLATE			
 <ul style="list-style-type: none"> Pneumatic dual flush push plate Compatible with wall hung frames & in wall cisterns 	Black	TR9029	£141.90
TOUCH SENSOR DUAL FLUSH PLATE			
 <ul style="list-style-type: none"> Activated by the lightest touch. Dual flush. Best for use in furniture installations where flush plate is lower down. If used within furniture, suitable for standard depth only. Battery operated (4 x AA batteries - lasts up to 2 years). 	Black	TR9016	£177.30
CONTACTLESS SENSOR DUAL FLUSH PLATE			
 <ul style="list-style-type: none"> Activated by a wave of a hand. Dual flush. Best for use in in-wall installations. If used within furniture, suitable for standard depth only. Battery operated (4 x AA batteries - lasts up to 2 years). 	Black	TR9025	£177.30
TRADITIONAL FLUSH PLATE			
 <ul style="list-style-type: none"> Pneumatic dual flush push plate. Compatible with wall hung frames & in-wall cisterns. Traditional styled buttons. 	Chrome	TR9017	£57.20
PLAZA FLUSH PLATE			
<ol style="list-style-type: none">     <ul style="list-style-type: none"> Pneumatic dual flush push plate. Compatible with wall hung frames & in-wall cisterns. Stainless steel flush plate surface is anti fingerprint. 	<ol style="list-style-type: none"> Chrome Black Stainless Steel Brushed Brass 	TR9010 TR9020 TR9019 TR9036	£49.70 £61.00 £118.20 £99.40
RONDO FLUSH PLATE			
<ol style="list-style-type: none">    <ul style="list-style-type: none"> Pneumatic dual flush push plate. Compatible with wall hung frames & in-wall cisterns. 	<ol style="list-style-type: none"> Chrome Black Brushed Brass 	TR9012 TR9021 TR9037	£49.70 £61.00 £99.40
RONDO FLUSH PLATE			
 <ul style="list-style-type: none"> Pneumatic dual flush push plate. Compatible with wall hung frames & in-wall cisterns. 	Chrome	TR9004	£49.70
SQUARE FLUSH BUTTON			
<ol style="list-style-type: none">    <ul style="list-style-type: none"> Pneumatic dual flush button. Compatible with concealed cisterns. If used with wall hung frames provision must be made for access in lieu of flush plate. 	<ol style="list-style-type: none"> Chrome Black Brushed Brass 	TR9003 TR9028 TR9035	£18.30 £23.00 £46.00
ROUND FLUSH BUTTON			
<ol style="list-style-type: none">   <ul style="list-style-type: none"> Pneumatic dual flush button. Compatible with concealed cisterns. If used with wall hung frames provision must be made for access in lieu of flush plate. 	<ol style="list-style-type: none"> Black Brushed Brass 	TR9022 TR9034	£23.00 £46.00
OVAL FLUSH BUTTON			
<ol style="list-style-type: none">   <ul style="list-style-type: none"> Specifically designed for furniture installations. Maximises flush interface. Compatible with concealed cisterns (not compatible with comfort cisterns in slim depth furniture). 	<ol style="list-style-type: none"> Chrome Black 	TR9023 TR9040	£62.80 £78.50

Note: Due to the depth of the comfort height cistern it is not compatible with the use of flush plates in furniture installations



SANITARYWARE

Flushing Options	Finish	Code	Price
CISTERN CONTACTLESS DUAL FLUSH REMOTE SENSOR KIT			
 <ul style="list-style-type: none"> Touchless flush activation. Dual flush. Best for use with concealed cisterns. Battery operated (4 x AA batteries - lasts up to 2 years). Provision must be made for access if installed in-wall. 	Black	TR9014	£158.50
Semi-Countertop Basins			
PARADIGM 475MM STANDARD DEPTH SEMI-COUNTERTOP BASIN 1 TAP HOLE			
 <ul style="list-style-type: none"> Suitable for use with standard depth furniture. Supplied with cutting template for worktop and fascia. Single tap hole & overflow. 	White	DC14029	£167.10
PARADIGM 475MM SLIM DEPTH SEMI-COUNTERTOP BASIN 1 TAP HOLE			
 <ul style="list-style-type: none"> Suitable for use with slim depth furniture. Supplied with cutting template for worktop and fascia. Single tap hole & overflow. 	White	DC14028	£142.90
ACCENT 560MM STANDARD DEPTH SEMI-COUNTERTOP BASIN 1 TAP HOLE			
 <ul style="list-style-type: none"> Suitable for use with standard depth furniture. Supplied with cutting template for worktop and fascia. Single tap hole & overflow. 	White	A3SCBAS	£364.40
ACCENT 560MM SLIM DEPTH SEMI-COUNTERTOP BASIN 1 TAP HOLE			
 <ul style="list-style-type: none"> Suitable for use with slim depth furniture. Supplied with cutting template for worktop and fascia. Single tap hole & overflow. 	White	A2SCBAS	£344.00
HARROW STANDARD DEPTH SEMI-COUNTERTOP BASIN 1 TAP HOLE			
 <ul style="list-style-type: none"> Suitable for use with standard depth furniture. Supplied with cutting template for worktop and fascia. Single tap hole & overflow. 	White	SCSB850S	£199.90

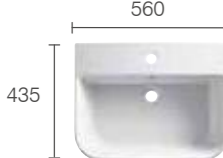
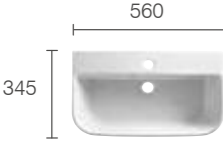
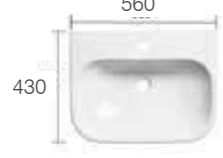
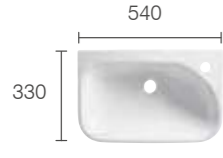
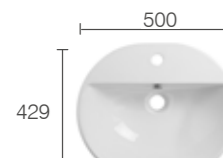
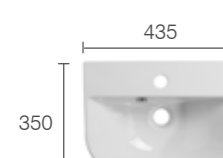

SANITARYWARE

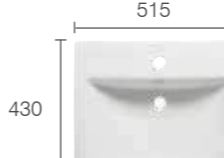

Semi-Countertop Basins	Finish	Code	Price
HARROW STANDARD DEPTH SEMI-COUNTERTOP BASIN 2 TAP HOLES			
 <p>550 435</p> <ul style="list-style-type: none"> Suitable for use with standard depth furniture. Supplied with cutting template for worktop and fascia. Two tap hole with overflow and chainstay hole. 	White	SCDB850S	£199.90
COVER STANDARD DEPTH 560MM SEMI-COUNTERTOP BASIN			
 <p>560 435</p> <ul style="list-style-type: none"> Suitable for use with standard depth furniture. Supplied with cutting template for worktop and fascia. 	White	C3SCBAS	£277.30
COVER 560MM SLIM DEPTH SEMI-COUNTERTOP BASIN			
 <p>560 345</p> <ul style="list-style-type: none"> Suitable for use with slim depth furniture. Supplied with cutting template for worktop and fascia. 	White	C2SCBAS	£261.20
NOTE 560MM STANDARD DEPTH SEMI-COUNTERTOP BASIN			
 <p>560 430</p> <ul style="list-style-type: none"> Suitable for use with standard depth furniture. Supplied with cutting template for worktop and fascia. Single tap hole & overflow. 	White	N3SCBAS	£385.90
NOTE 540MM SLIM DEPTH SEMI-COUNTERTOP BASIN			
 <p>540 330</p> <ul style="list-style-type: none"> Suitable for use with slim depth furniture. Supplied with cutting template for worktop and fascia. Single tap hole & overflow. 	White	N2SCBAS	£365.50
ZEST 500MM STANDARD DEPTH SEMI-COUNTERTOP BASIN			
 <p>500 429</p> <ul style="list-style-type: none"> Suitable for use with standard depth furniture. Supplied with cutting template for worktop and fascia. Single tap hole & overflow. 	White	Z3SCBAS	£368.70
ZEST 435MM SLIM DEPTH SEMI-COUNTERTOP BASIN			
 <p>435 350</p> <ul style="list-style-type: none"> Suitable for use with slim depth furniture. Supplied with cutting template for worktop and fascia. Single tap hole & overflow. 	White	Z2SCBAS	£324.60





SANITARYWARE

Semi-Countertop Basins	Finish	Code	Price
GEO 515MM STANDARD DEPTH SEMI-COUNTERTOP BASIN			
 <p>515 430</p> <ul style="list-style-type: none"> Suitable for use with standard depth furniture. Supplied with cutting template for worktop and fascia. Single tap hole & overflow. 	White	G3SCBAS	£245.60
GEO 540MM SLIM DEPTH SEMI-COUNTERTOP BASIN			
 <p>540 218</p> <ul style="list-style-type: none"> Suitable for use with slim depth furniture. Supplied with cutting template for worktop and fascia. Single tap hole & overflow. 	White	G2SCBAS	£226.20
Overflow Trims		Finish	Code
OVERFLOW TRIMS			
 <ul style="list-style-type: none"> Coordinate with brassware and handles. Chrome trims are provided as standard. <p>* Specify at time of ordering</p>	<ul style="list-style-type: none"> * White * Black * Brushed Brass 	OVC22WT OVC22BK OVC22BR	
		£10.00 each	

CABINETS

Cabinets	Code	Size	Price
ORIGIN			
	RGC050	500(w) x 700(h) x 140(d)	£795.50
	RGC060	600(w) x 700(h) x 140(d)	£908.30
	RGC080	800(w) x 700(h) x 140(d)	£1,053.50
<ul style="list-style-type: none"> Multi-function infrared control. LED illuminated side panels. Dual charging options. Two-pin charging & USB. Double sided mirror doors. Adjustable aluminum shelving system. Single door cabinet is left hinged. 			



Cabinets	Code	Size	Price
NOTION			
	NTC050	490(w) x 700(h) x 120(d)	£709.50
	NTC060	590(w) x 700(h) x 120(d)	£822.30
	NTC080	790(w) x 700(h) x 120(d)	£940.60
<ul style="list-style-type: none"> Multi-function infrared control. Compatible with the Loop vanity mirror see page 94 for details. Centre column, ideal for attaching the loop vanity mirror. Dual charging options (Inc USB-C). 2-pin charging. Double sided mirror doors. Single door cabinet is left hinged. 			





Cabinets	Code	Size	Price
PRESENCE			
	PSC050	500(w) x 700(h) x 130(d)	£677.20
	PSC065	650(w) x 700(h) x 130(d)	£854.60
	PSC080	800(w) x 700(h) x 130(d)	£908.30
	PSC100	1000(w) x 700(h) x 130(d)	£1,015.80
<ul style="list-style-type: none"> Multi-function touch control. Dual charging options. 2-pin charging. Double sided mirrored doors. Single door cabinet is left hinged. 			

Cabinets	Code	Size	Price
SYSTEM			
	SYC050	500(w) x 700(h) x 140(d)	£688.00
	SYC060	600(w) x 700(h) x 140(d)	£854.60
	SYC100	1000(w) x 700(h) x 140(d)	£1,015.80
<ul style="list-style-type: none"> Multi-function infrared control. Dual charging options. Double sided mirrored doors. Single door cabinet is left hinged. 			



*** Infrared Sensor** The position of infrared sensors is indicated on each cabinet with this symbol **Important** When mounting cabinets with infrared sensors, the sensor must be at least 150mm from an adjacent wall or obstruction to ensure the sensor can function properly.

CABINETS & MIRRORS



















Cabinets	Code	Size	Price
BOOST			
	BTC050	490(w) x 800(h) x 120(d)	£795.50
	BTC060	590(w) x 800(h) x 120(d)	£940.60
	BTC080	790(w) x 800(h) x 120(d)	£1,053.50
<ul style="list-style-type: none"> Multi-function infrared control. Wireless charging pad. Dual charging options (Inc USB-C). 2-pin charging. Double sided mirror doors. Can be recessed. Refer to technical datasheet on website for more information. Removable mirrored side panels. Single door cabinet is left hinged. 			

Cabinets	Code	Size	Price
PURPOSE			
	PUC050	500(w) x 700(h) x 20(d)	£677.20
	PUC065	650(w) x 700(h) x 20(d)	£854.60
	PUC080	800(w) x 700(h) x 20(d)	£908.30
	PUC100	1000(w) x 700(h) x 20(d)	£1,015.80
<ul style="list-style-type: none"> Recessed cabinet. Multi-function touch control. Dual charging options. 2-pin charging. Double sided mirrored doors. Single door cabinet is left hinged. <p>For recessed installations, a minimum recess depth of 70mm is required.</p>			

Cabinets	Code	Size	Price
THEORY			
	TYC045	450(w) x 700(h) x 120(d)	£368.70
	TYC060	600(w) x 700(h) x 120(d)	£425.70
<ul style="list-style-type: none"> Double sided mirror doors. Single door is left hinged. Matt black finish. 			











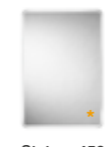

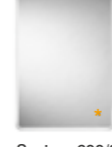



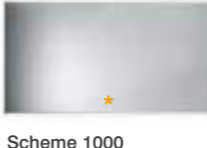
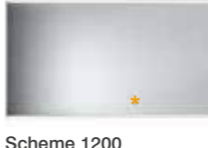

Mirrors	Code	Size	Price
LOOP			
	VM01	Loop vanity mirror 140(diameter) x 200(d)	£198.80
	VMM60C	Loop 600 mirror & vanity mirror 600(diameter) x 34(d)	£596.60
	VMM80C	Loop 800 mirror & vanity mirror 800(diameter) x 34(d)	£709.50
<ul style="list-style-type: none"> Handheld vanity mirror with 3x magnification. Supplied with wireless charging stand and USB cable. Touch control operation. Adjustable LED colour temperature & brightness. Wall mirror with detachable Loop, vanity mirror, wireless charging stand & USB cable included. Vanity mirror wireless charging ring on bottom right of wall mirror Touch control operation. Adjustable LED colour temperature & brightness. Heated demister pad prevents mirror steaming up. 			

MIRRORS

Mirrors	Code	Size	Price
PLAY			
 Play 600 circular PYM60C	 Play 800 circular PYM80C	 Play 500 PYM050	<ul style="list-style-type: none"> Listen to your playlists via Bluetooth® Wireless Technology. Integrated resonance speakers. Touch control. Control your music via your smart phone or tablet. Adjustable LED warmth and brightness and temperature to create tailored bathroom experiences, from an invigorating morning daylight white (6000K) to a comforting evening warm white (2700K). Slim design.
PYM60C 600(diameter) x 31(d) £425.70 PYM80C 800(diameter) x 31(d) £510.60 PYM050 500(w) x 700(h) x 31(d) £425.70			
FRAME			
 Frame Circular 600 FR60RW / FR60RG FR60RB	 Frame Circular 800 FR80RW / FR80RG FR80RB	 Frame Pill FR50PG	<ul style="list-style-type: none"> Coordinates with Frame furniture. Most variants available in black, brushed brass or white finishes. Multi-function infrared switch. Adjustable LED brightness and temperature to create tailored bathroom experiences, from an invigorating morning daylight white (6000K) to a comforting evening warm white (2700K).
 Frame 600/800 FR60SW / FR60SG	 Frame 1200 FR120SW / FR120SG	 Frame Oval FR50VG / FR50VB	<ul style="list-style-type: none"> Coordinates with Frame furniture. Most variants available in black, brushed brass or white finishes. Multi-function infrared switch. Adjustable LED brightness and temperature to create tailored bathroom experiences, from an invigorating morning daylight white (6000K) to a comforting evening warm white (2700K).
FR50PG (black) 500 x 800 x 38 £425.70 FR50VG (black) 500 x 700 x 38 £397.70 FR50VB (brushed brass) 500 x 700 x 38 £429.00 FR60RW (white) Ø600 x 38(d) £378.40 FR60RG (black) Ø600 x 38(d) £378.40 FR60RB (brushed brass) Ø600 x 38(d) £399.00 FR80RW (white) Ø800 x 38(d) £507.40 FR80RG (black) Ø800 x 38(d) £507.40 FR80RB (brushed brass) Ø800 x 38(d) £529.00 FR60SW (white) 600(w) x 800(h) x 38(d) £507.40 FR60SG (black) 600(w) x 800(h) x 38(d) £507.40 FR120SW (white) 1200(w) x 600(h) x 38(d) £677.20 FR120SG (black) 1200(w) x 600(h) x 38(d) £677.20			
EMINENCE			
 Eminence Oval EM650AL	 Eminence Pill EM80PAL	 Eminence Circular 550 EM55CAL	<ul style="list-style-type: none"> Multi-function infrared switch. Adjustable LED brightness and temperature to create tailored bathroom experiences, from an invigorating morning daylight white (6000K) to a comforting evening warm white (2700K).
 Eminence Circular 800 EM80CAL	 Eminence 500 EM70RAL	 Eminence 600 EM80RAL	<ul style="list-style-type: none"> Multi-function infrared switch. Adjustable LED brightness and temperature to create tailored bathroom experiences, from an invigorating morning daylight white (6000K) to a comforting evening warm white (2700K).
EM650AL 490(w) x 650(h) x 35(d) £385.90 EM80PAL 500(w) x 800(h) x 35(d) £452.50 EM55CAL 500(diameter) x 35(d) £344.00 EM80CAL 800(diameter) x 35(d) £434.30 EM70RAL 500(w) x 700(h) x 35(d) £493.40 EM80RAL 600(w) x 800(h) x 35(d) £513.80			
ACADEMY			
 Academy 500/700 ACM050	 Academy 600/700 ACM060	 Academy 1000 ACM100	<ul style="list-style-type: none"> Multi-function infrared switch. Adjustable LED brightness and temperature to create tailored bathroom experiences, from an invigorating morning daylight white (6000K) to a comforting evening warm white (2700K). LED illuminated frame. Slim design.
ACM050 500(w) x 700(h) x 25(d) £441.80 ACM060 600(w) x 800(h) x 25(d) £480.50 ACM100 1000(w) x 600(h) x 25(d) £529.90			

*** Infrared Sensor** The position of infrared sensors is indicated on each cabinet with this symbol
Important When mounting cabinets with infrared sensors, the sensor must be at least 150mm from an adjacent wall or obstruction to ensure the sensor can function properly.



MIRRORS

Mirrors	Code	Size	Price
SYSTEM			
 System 450 SYS45AL	 System 500/700 SYS70AL	 System 600/800 SYS80AL	<ul style="list-style-type: none"> Multi-function infrared switch. Adjustable LED brightness and temperature to create tailored bathroom experiences, from an invigorating morning daylight white (6000K) to a comforting evening warm white (2700K).
 System 700/900 SYS90AL	 System 1200 SYS120AL		SYS45AL 450(w) x 700(h) x 25(d) £460.10 SYS70AL 500(w) x 700(h) x 25(d) £482.60 SYS80AL 600(w) x 800(h) x 25(d) £513.80 SYS90AL 700(w) x 900(h) x 25(d) £548.20 SYS120AL 1200(w) x 600(h) x 25(d) £671.80
SCHEME			
 Scheme 500 MLE470C	 Scheme 600 MLE530C	 Scheme 800 MLE540C	<ul style="list-style-type: none"> Multi-function infrared switch. Adjustable LED brightness and temperature to create tailored bathroom experiences, from an invigorating morning daylight white (6000K) to a comforting evening warm white (2700K).
 Scheme 1000 MLE550C	 Scheme 1200 MLE560C		MLE470C 500(w) x 710(h) x 47(d) £449.30 MLE530C 600(w) x 470(h) x 47(d) £408.50 MLE540C 800(w) x 470(h) x 47(d) £449.30 MLE550C 1000(w) x 470(h) x 47(d) £529.90 MLE560C 1200(w) x 470(h) x 47(d) £618.10
LEAP			
 Leap 500/700 LE70ALU	 Leap 600/800 LE80ALU	 Leap 1200 LE120ALU	<ul style="list-style-type: none"> Infrared on/off switch. Dual charging options. Two-pin charging & USB. Tapered body design.
LE70ALU 500(w) x 700(h) x 55(d) £513.80 LE80ALU 600(w) x 800(h) x 55(d) £537.50 LE120ALU 1200(w) x 600(h) x 55(d) £677.20			
THEESIS			
 Thesis 600 circular TNM60C (black) TNM60C-BR (brushed brass)	 Thesis 800 circular TNM80C (black) TNM80C-BR (brushed brass)	 Thesis pill TNM50P	<ul style="list-style-type: none"> Black or brushed brass frame around the outside of the mirror. Compatible with the Loop vanity mirror see page 96 for details. Add 'VM' suffix to the code when ordering to include the Loop Vanity Mirror. PLEASE NOTE: The Loop (mirror plus vanity mirror) bundle is only available in the black colour.
 Thesis oval TNM50V (black) TNM50V-BR (brushed brass)	 Thesis 450/700 TNM045	 Thesis 600/800 TNM060	<ul style="list-style-type: none"> Black or brushed brass frame around the outside of the mirror. Compatible with the Loop vanity mirror see page 96 for details. Add 'VM' suffix to the code when ordering to include the Loop Vanity Mirror. PLEASE NOTE: The Loop (mirror plus vanity mirror) bundle is only available in the black colour.
TNM60C 600(diameter) x 38(d) £135.40 TNM80C 800(diameter) x 38(d) £191.80 TNM50P 500(w) x 800(h) x 38(d) £180.60 TNM50V 500(w) x 700(h) x 38(d) £169.30 TNM045 450(w) x 700(h) x 38(d) £146.70 TNM060 600(w) x 800(h) x 38(d) £180.60 TNM60C-BR 600(diameter) x 38(d) £149.00 TNM80C-BR 800(diameter) x 38(d) £209.00 TNM50V-BR 500(w) x 700(h) x 38(d) £189.00 TNM60C-VM 600(diameter) x 38(d) £317.10 TNM80C-VM 800(diameter) x 38(d) £374.10 TNM50P-VM 500(w) x 800(h) x 38(d) £362.20 TNM50V-VM 500(w) x 700(h) x 38(d) £350.40 TNM045-VM 450(w) x 700(h) x 38(d) £327.80 TNM060-VM 600(w) x 800(h) x 38(d) £362.20			

*** Infrared Sensor** The position of infrared sensors is indicated on each cabinet with this symbol
Important When mounting cabinets with infrared sensors, the sensor must be at least 150mm from an adjacent wall or obstruction to ensure the sensor can function properly.

MIRRORS, LIGHTING & CHARGING STATION

Mirrors	Code	Size	Price	
TRADITIONAL MIRRORS				
 <p>Traditional 430 WMB2022</p>	<ul style="list-style-type: none"> Slim design. Includes demister pad. 	WMB2022	430(w) x 700(h) x 30(d)	£249.40
		WMB2020	600(w) x 900(h) x 30(d)	£308.50
		WMB2023	1200(w) x 600(h) x 30(d)	£427.80
 <p>Traditional 600 WMB2020</p>				
 <p>Traditional 1200 WMB2023</p>				

Lighting	Code	Size	Price	
WALL LIGHT				
	<ul style="list-style-type: none"> Supplied with integrated LED lighting (4000K colour temperature). 	LIGHT01	60(w) x 550(h) x 80(d)	£209.00 each
		WMB2030	60(w) x 410(h) x 90(d)	£189.70 each
	<ul style="list-style-type: none"> Supplied with integrated LED lighting (4000K colour temperature). 			

300MM CHROME LED LIGHT	Code	Size	Price	
	<ul style="list-style-type: none"> For use on top of cabinets or mirrors. 6 watt LED light. Light is IP44 rated. Supplied with driver suitable for mounting outside bathroom. zones 1 & 2 - behind mirror or cabinet. 	LED300WL	-	£81.20

Charging Station	Code	Size	Price	
FITTED FURNITURE ACCESSORY				
	<ul style="list-style-type: none"> For use within furniture. x1 USB slot. x1 two-pins charging slot with rocker switch. Flap to cover ports. Mains connection required. Supplied with a three core flying lead. See page 112 for more details. 	DC6001	-	£147.80

Customer service & aftercare

PLANNING TIPS AND ADVICE

LOCATING THE PRINCIPLE ITEMS

Wherever possible, try and install your WC, basin, bath and/or shower in a similar position to that in your current bathroom in order to minimise installation time and costs.

PLANNING - KEY STEPS

- Measure your bathroom and draw out a plan, to scale if possible.
- Make reference to where all services are located including soil pipes and water inlets.
- Ensure all dimensions of heights/widths of windows and radiator positions are marked up on your plan.
- Take note of the direction the door opens as this could affect your layout. If it is a hindrance, your door could easily be re-hung by a professional to allow more flexibility.

Once you have the outline of your bathroom, you can experiment by placing different units within your plan. See pages 16-17 for full details of the different sized units available. If you have an odd space at one end of a run of furniture, for example if fitting between two walls or a wall and a bath, then filler panels can be used. The worktop can run across the top of the furniture between the two walls to create a continuous look. Our storage shelf units are supplied in a flat pack format, allowing your installer to cut down the width of the shelves and base components from the nominal 300mm width so that the unit can be customised to suit any size.

When you are happy with your initial design layout, take it to your Roper Rhodes stockist. Your retailer may come up with some further design ideas which may help inspire you.

CORNERS

If due to the size of your room there is an odd space, then two pieces of filler panel can be used to space the units as necessary.

Worktops can be fitted together on top of your corner configuration using a mason's mitre jig and worktop jointing bolts. Your bathroom fitter will be able to advise further.

WC UNITS

The use of a WC unit and concealed cistern can create a clean uncluttered look for your bathroom. Dual flush concealed cisterns available from us operate by a pneumatic push button which can be sited in the front removable fascia of the WC unit, or on the top of the unit if desired.* Our WC units feature a panel which goes to the floor, removing the need for unsightly filler blocks that are sometimes used to fill the void between the back to wall WC pan and the plinth. As a consequence, it is recommended that when fitting commences, the WC unit height is set first with the other units running off. If the floor of the installation is uneven, then the main fascia panel can be scribed to fit.

If a wall hung WC pan is required, then a suitable supporting frame must be used see page 87. Never fit a wall hung pan directly to the fascia of a WC unit only. Speak to your retailer for more details on compatibility.

BASINS

Our semi-countertop basins are available in both slim and standard depth formats and can be mounted on both laminate and solid surface worktops by an experienced fitter.

SLIM DEPTH FURNITURE

The key units within our Fitted Furniture range are available in both standard and slimline formats. Using slimline furniture in small ensuites or cloakrooms can help maintain vital space in the room without sacrificing bathroom storage.

* Only with standard depth WC units. Flush buttons can only be installed on the front fascia of slimline units.

PLANNING TIPS AND ADVICE

CONCEALING PIPEWORK

One of the benefits of using our Fitted Furniture is that unsightly pipework can run along skirting boards and walls whilst being concealed behind the units. The furniture is designed with a plinth height of 180mm, which means that even soil pipes can run under the units.

All standard depth base units feature a generous 50mm void at the back, which allows waste pipes and copper pipes to run along the walls whilst being concealed behind the units. Your fitter will only have to notch out the side panel of the unit where the pipe traverses. In addition to the 50mm pipe void, basin units in both slim and standard depth configurations feature a removable back panel to aid the installation process. (See diagrams below).

ELECTRICS & CHARGER POINT DETAILS

When planning your bathroom, note where any lighting or electrical supply cables are situated. It may be necessary to move these. It is advised that this work is done after the old bathroom fittings are removed but before the new installation begins. Always use a qualified electrician for any work carried out in a bathroom. Your retailer may be able to advise when to schedule an electrician, or consult your fitter or electrician for more advice. Please note that Roper Rhodes cannot give specific advice on electrical installations.

When planning where to locate lighting, it is vital that the IP rating of the device is taken into account as this will affect which zone of the bathroom the fitting can be located in. Your electrician will be able to advise further on bathroom zones and which electrical appliances can be sited where. Remember to allow for the provision of switching for any new lighting.

It is recommended that, whilst you are at the planning stage, you make an allowance for the installation of a suitable extractor fan to remove excess water from the atmosphere. After the furniture has been fitted, plan for an electrician to come back and install light fittings or electrical devices which are used.

MIRRORS

Our mirrors (over 560mm wide) feature heated mirror pads to prevent them from misting up. Your electrician can connect the heated mirror pad to the domestic supply so that the pad is switched on and off when your bathroom lighting is operated. Heater pads should not be connected to a permanently live supply. Please note, mirrors must never be installed above a bath or shower.

PLANNING TIPS AND ADVICE

FILLER PANELS

Filler panels are available to fill gaps at the ends of runs of furniture and to clad ends of furniture for a perfect match.

CLAD-ON DESIGN END PANELS

Clad-on design end panels are available in slim and standard depth configurations and are 25-30mm thick (depending on the finish, see pages 138-141 for further information). Give a different style to your bathroom design by cladding these to the sides of units for a framed look. Design panels are 820mm tall, allowing them to run from the floor to the underside of the worktop if necessary. They can be cut down if base units are wall hung. The slim design panels can also be cut down to be used with wall cabinets or wall cupboards.

You can achieve very different effects by contrasting the panels and fascias of units. Matching colours between doors and accent panels creates a subtle yet 'solid framed' look.

HANDLES

The comprehensive range of handles in the our range allows a multitude of looks to be created. Move them into different positions on the door, or change their orientation, to create the look you want on your furniture.

Please note that all doors will require your fitter to drill and fit your handles so that you can position them exactly where you want.

BATH PANELS

Designed to complement all door styles. Both front and end panels are supplied with a matching plinth which allows for adjustment depending on site conditions. To achieve a continuous look between the furniture and the bath panel, it is recommended that the panel is set at a height of 520mm, so that a plinth height of 180mm is achieved.

Note: Once installed all bath panels must be sealed along the top, bottom and sides with a suitable silicone sealant to prevent damage from excessive moisture.

CORNER POSTS (FOR BATH PANELS)

Designed to provide a neat joint on an exposed corner of a bath between front and end panels. The corner posts can also be used to allow larger sized bath tubs to be accommodated with the panels available in the range. A corner post will add 50mm in length to a panel, so using two corner posts would allow an 1800mm tub to be installed.

Please note: Corner posts only available for painted finishes.

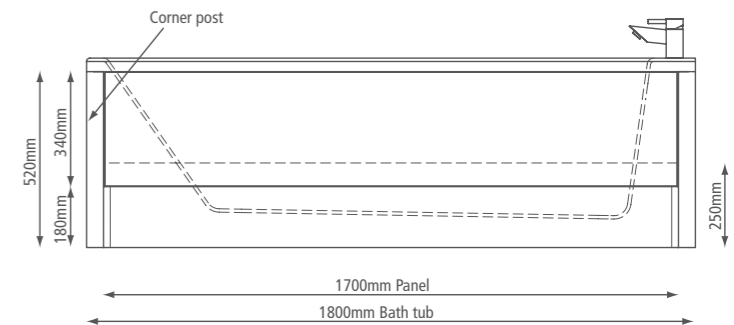

PLUMBING VOIDS

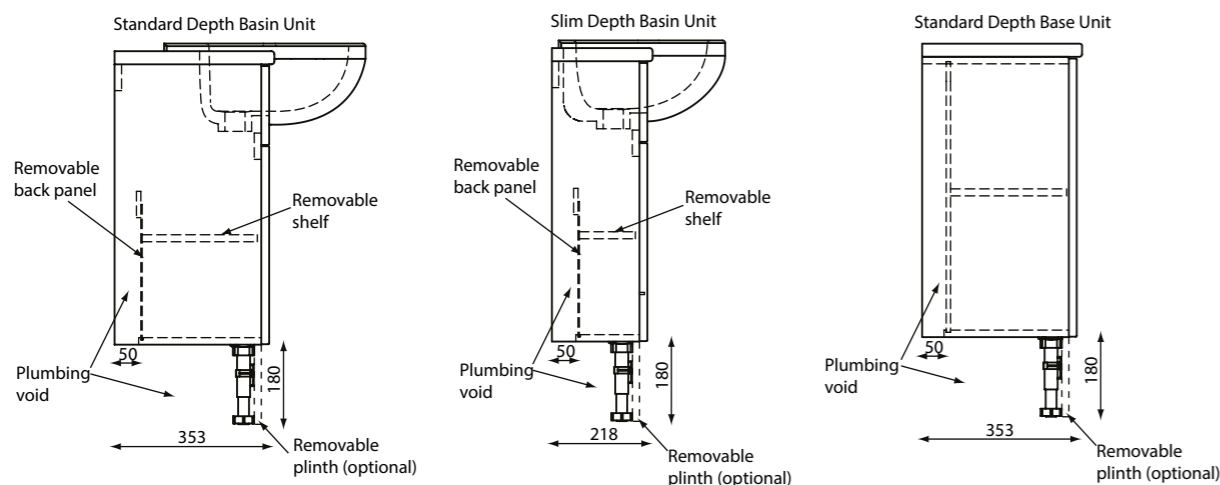

Keeping in touch

CUSTOMER SERVICE & AFTERCARE

As one of the UK's largest suppliers of bathroom furniture & accessories, we set very high standards in design, manufacture & service. We also invest heavily in product improvement & innovation. By choosing Roper Rhodes, you can be confident that your product is of unrivalled quality.



OUR BROCHURES

Explore the rest of the Roper Rhodes collection with our core Bathroom Book and dedicated Mirrors & Cabinets brochures. Ask your local retailer for a copy or visit our website to order or download one.
roperrhodes.co.uk/brochures



RETAILERS

Roper Rhodes products are available to view at our selected specialist stockists throughout the UK and Ireland. Head over to our website now to find your nearest supplier.
roperrhodes.co.uk/stockists/



SWATCH SAMPLE SERVICE

Our free swatch sample service is designed to help you make the right finish choices for your home. If you would like a sample of any of our finishes please visit our website and fill in the sample request form.
roperrhodes.co.uk/swatches

Alternatively you will find displays of our furniture and colour samples of finishes and worktops at our specialist retailers across the UK and Ireland.



WEBSITE

Visit our website to find even more inspiration for your next bathroom project, with detailed guides and inspiring articles. Here you can also find technical details for all our products, as well as access our customer service team and list of stockists.
roperrhodes.co.uk

As one of the UK's largest suppliers of bathroom furniture and accessories, we set very high standards in design, manufacture and service. We also invest heavily in product improvement and innovation to ensure complete customer satisfaction. We will make every effort to supply all products ordered in as short a lead time as possible. Our standard delivery is three days. Should you require next day delivery this can be arranged.

HOW TO CONTACT US

If you need to contact us, our experienced in-house customer service team has a wealth of knowledge about our products.

01225 303900

sales@roperrhodes.co.uk

Monday to Thursday - 9:00am - 5:30pm

Friday - 9:00am - 5:00pm

DELIVER

Our Fitted Furniture must be installed by a qualified fitter. In the unlikely event that your product is damaged or faulty in any way, this must be notified on receipt, and must not under any circumstances be fitted. Time must be allowed between delivery and installation for checking items and the delivery of subsequent replacements. Attention is drawn to the policy of replacing any damaged part with a spare part where possible. Complete exchanges will only be made if damage is excessive. We shall not be liable for any further unfitting/refitting costs or financial compensation. Components/products that are deemed defective as a result of incorrect or substandard installation or improper or negligent use will be excluded from any guarantee claim. Roper Rhodes Ltd reserve the right to amend specifications at any time if an opportunity to further improve the product occurs.

Doors and fascias are supplied separately to the furniture units, to prevent them from being damaged during the installation process. Doors are simply fixed by your fitter screwing the necessary hardware to the backs of the doors or fascias and simply clicking into place on the relevant hinge plate inside the unit. Mirror glass cabinets are supplied with doors installed. Doors / drawer fascias are supplied un-drilled for handles due to the wide variety of handles and possible positions. Any competent fitter will be able to fit them in the positions which best suit the design of your individual bathroom. All units are supplied assembled with the exception of the storage shelf units (which can be modified if necessary to fit a smaller gap).

INSTALLATION

Our bathroom furniture is designed for use within domestic installations which are adequately ventilated. As with any timber product, bathroom furniture will be adversely affected if it is subjected to excessive moisture. It is strongly recommended that adequate bathroom extractor fans are installed to prevent heavy condensation and all splashes and spillages must be mopped dry as soon as possible. All exposed or cut surfaces must be sealed with a suitable varnish or silicone sealant to prevent blowing. If this is not done, all guarantee claims will be void. In particular, silicone sealant must be used around basins and worktop joints, and around all edges of bath panels and plinths if the sealer strip is not utilised. All electrical products should be installed by an approved electrician in line with current wiring regulations. Guarantees are for domestic use only and not transferable.

PRODUCT SPECIFICATION

The furniture colours shown in this brochure are representative only and can be affected by a multitude of factors such as lighting and surrounding items. If you are unsure we would recommend obtaining a swatch.

All timber finishes featured within this brochure are timber effect. Please note that there may be some slight variation between carcasses, doors and worktops due to different manufacturing techniques used.

All dimensions are approximate, especially with ceramic sanitaryware where a tolerance of +/- 2% must be allowed.

ACKNOWLEDGEMENTS

Viewpoint photography - viewpoint-photography.co.uk - 01761 420841

Porcelanosa - porcelanosa.co.uk - 0800 915 4000

Mandarin Stone - mandarinstone.com - 01600 715 444

Ca'Pietra by Optimum Stone showroom - capietra.com - 01252 843388

The Radiator Co. - theradiatorcompany.co.uk - 01342 302250

Iconic - iconicradiators.co.uk - 01342 305579



A close-up photograph of two dark teal cabinet doors. Each door features a recessed rectangular panel and a round brass knob positioned near the top center. The doors are set against a matching teal background.

ROPER RHODES®
BATH

Brassmill Lane Trading Estate, Bath, BA1 3JF
RRFFSEP22 v2